

922



82- SUBMISSIONS FACING SHEET

MICROFICHE CONTROL LABEL



REGISTRANT'S NAME

Chorus Motors plc

*CURRENT ADDRESS

Montagu Pavilion
8-10 Queensway
Gibraltar

**FORMER NAME

PROCESSED

**NEW ADDRESS

JAN 05 2007



FILE NO. 82-

35057

FISCAL YEAR

• Complete for initial submissions only •• Please note name and address changes

INDICATE FORM TYPE TO BE USED FOR WORKLOAD ENTRY:

12G3-2B (INITIAL FILING)

AR/S (ANNUAL REPORT)

12G32BR (REINSTATEMENT)

SUPPL (OTHER)

DEF 14A (PROXY)

OICF/BY: [Signature]

DATE: 1/3/07

THE COMPANIES ORDINANCE
OF THE LAWS OF GIBRALTAR
PUBLIC LIMITED COMPANY LIMITED BY SHARES

Amended - 25 June 2003

MEMORANDUM OF ASSOCIATION
OF

CHORUS MOTORS PUBLIC LIMITED COMPANY

GIBRALTAR COMPANY NUMBER 68312

RECEIVED
2006 AUG 22 A 9:56
OFFICE OF INTERNATIONAL
CORPORATE FINANCE

1. **NAME**

The name of the Company is CHORUS MOTORS PUBLIC LIMITED COMPANY.

2. **REGISTERED OFFICE**

The Registered Office of the Company will be situated in Gibraltar.

3. **GENERAL OBJECTS AND POWERS**

- (1) The Company is a public company limited by shares.
- (2) The object of the Company is to engage in any act or activity that is not prohibited under any law for the time being in force in Gibraltar.
- (3) The Company may not:
 - a) carry on business with persons resident in Gibraltar;
 - b) own an interest in real property situated in Gibraltar, other than a lease referred to in paragraph (e) of sub-clause (4);
 - c) carry on banking or trust business, unless it is licensed to do so under the Banking Ordinance and the Financial Services Ordinance respectively;
 - d) carry on business as an insurance or reinsurance company, insurance agent or insurance broker, unless it is licensed to do so under the Insurance Companies Ordinance and the Financial Services Ordinance respectively;
 - e) carry on the business of company management, unless it is licensed under the Financial Services Ordinance;
- (4) For purpose of paragraph (a) of subclause (3), the Company shall not be treated as carrying on business with the persons resident in Gibraltar if:
 - a) It makes or maintains deposits with a person carrying on banking business within Gibraltar
 - b) It makes or maintains professional contact with solicitors, barristers, accountants, bookkeepers, trust companies, administration companies, investment advisors or other similar persons carrying on business within Gibraltar;
 - c) It prepares or maintains books and records within Gibraltar;
 - d) It holds within Gibraltar meetings of its directors or members;
 - e) It holds a lease of property for use as an office from which to communicate with members or where books and records of the Company are prepared or maintained;
 - f) It holds shares, debt obligations or other securities in a company incorporated under The Companies Ordinance; or The Companies (Share Allotment and Capital Maintenance) Ordinance 1998.
 - g) Shares, debt obligations or other securities in the Company are owned by any person resident in Gibraltar or by any company incorporated under The Gibraltar Ordinance.
- (5) The Company shall have all such powers as are permitted by law for the time being in force in Gibraltar irrespective of corporate benefit, to perform all acts and engage in all activities which are necessary or conducive to the conduct, promotion or attainment of the object of the Company.
- (6) The Company shall have all powers to settle its assets or property or any part thereof in trust, or to transfer the same to any other company or entity, whether for the protection of its assets or not and with respect to such settlement or transfer the directors may provide that the Company, its creditors, its members or any person having a direct or indirect interest in the Company may be beneficiaries, creditors, members, certificate holders, partners or holders of any other similar interest, in such other company or entity.
- (7) The directors may, by resolution of directors, exercise all the powers of the Company to borrow money and to mortgage or charge its undertakings and property or any part thereof, to issue debentures, debenture stock and other securities whenever money is borrowed or as security for any debt, liability or obligation of the Company or of any third party subject to the limitations on such activity as defined in the Articles of Association for the Company.

(8) The Company may, by resolution of directors, mortgage, charge, sell, transfer, lease, exchange or otherwise encumber or dispose of any or all of the assets, undertakings and property of the Company, whether in the usual or regular course of the business of the Company or not, without authorisation by a resolution of members subject to the limitations on such activity as defined in the Articles of Association for the Company.

4. **CURRENCY**

Shares in the Company shall be issued in the currency of the United States of America.

5. **AUTHORISED CAPITAL**

The authorised capital of the Company is \$100,000 USD.

6. **CLASSES, MEMBER AND PAR VALUE OF SHARES**

The authorised capital is made up of one class of shares divided 10,000,000 shares of \$0.01 USD par value each.

7. **DESIGNATIONS, POWERS, PREFERENCES, ETC. OF SHARES**

The designations, powers, preferences, rights, qualifications, limitations and restrictions of each class and series of shares that the Company is authorised to issue shall be fixed by resolution of directors, but the directors shall not allocate different rights as to voting, dividends, redemption or distributions on liquidation unless the Memorandum of Association shall have been amended to create separate classes of shares and all the aforesaid rights as to voting, dividends, redemption and distributions shall be identical as among the shares in each separate class.

8. **VARIATION OF CLASS RIGHTS**

If at any time the authorised capital is divided into different classes or series of shares, the rights attached to any class or series (unless otherwise provided by the terms of issue of the shares of that class or series) may, whether or not the Company is being wound up, be varied with the consent of the holders of a two-thirds (2/3) majority of the issued shares of that class or series and of the holders of a two-thirds (2/3) majority of the issued shares of any other class or series of shares which may be affected by such variation.

9. **RIGHTS NOT VARIED BY THE ISSUE OF SHARES PARI PASSU**

Rights conferred upon the holders of the shares of any class issued with preferred or other rights shall not, unless otherwise expressly provided by the terms of issue of the shares of that class, be deemed to be varied by the creation or issue of further shares ranking pari passu therewith.

10. **TRANSFER OF SHARES**

Registered shares in the Company may be transferred without the prior or subsequent approval of the Company in such manner as the directors may decide.

11. **AMENDMENT OF MEMORANDUM AND ARTICLES OF ASSOCIATION**

The Company may amend its Memorandum of Association and Articles of Association in General meeting, as per the Articles of Association.

ENACTED this 25th day of June 2003

For CHORUS MOTORS PUBLIC LIMITED COMPANY,

WITNESS the Corporate
Seal of the Company.

Rodney T. Cox
CEO/Chairman

Isaiah W. Cox
President/COO

THE COMPANIES ORDINANCE
OF THE LAWS OF GIBRALTAR
PUBLIC LIMITED COMPANY LIMITED BY SHARES

Amended - 25 June 2003

ARTICLES OF ASSOCIATION
OF

CHORUS MOTORS PUBLIC LIMITED COMPANY
GIBRALTAR COMPANY NUMBER 68312

RECEIVED
2006 AUG 22 A 9:36
OFFICE OF INTERNATIONAL
CORPORATE FINANCE

INTERPRETATION

1. In these Articles, if not inconsistent with the subject or context, the words and expressions standing in the first column of the following table shall bear the meanings set opposite them respectively in the second column thereof.

Words	Meanings
capital	The sum of the aggregate par value of all outstanding shares with par value of the Company and shares with par value held by the Company as treasury shares, plus the amounts that are from time to time transferred from surplus to capital by a resolution of directors.
member person	A person who holds one or more shares in the Company. An individual, a corporation, a trust, the estate of a deceased individual, a partnership or an unincorporated association of persons.
resolution of directors	a) A resolution approved at a duly constituted meeting of directors of the Company or of a committee of directors of the Company by the affirmative vote of a simple majority of the directors present at the meeting in person, via e-mail or other electronic means, who voted and did not abstain; or b) a resolution consented to in writing by all directors or by all members of a committee, as the case may be. Except that where a director is given more than one vote, he shall then be counted by the number of votes he casts for the purpose of establishing a majority.
resolution of members	a) A resolution approved at a duly convened and constituted meeting of the members of the Company by the affirmative vote of I. a simple majority of the votes of the shares entitled to vote thereon which were present at the meeting in person, by proxy, via e-mail or other electronic means, and were voted and did not abstain, unless these Articles of Association require a different majority; or II. a simple majority of the votes of each class or series of shares which were present at the meeting in person, by proxy, via e-mail or other electronic means, and entitled to vote thereon as a class or series and were voted and did not abstain and of a simple majority of the votes of the remaining shares entitled to vote thereon which were present at the meeting in person, by proxy, via e-mail or other electronic means, and were voted and did not abstain, unless these Articles of Association require a different majority; or b) a resolution consented to in writing by I. an absolute majority of the votes of shares entitled to vote thereon, unless these Articles of Association require a different majority; or II. an absolute majority of the votes of each class or series of shares entitled to vote thereon as a class or series and of an absolute majority of the votes of the remaining shares entitled to vote thereon, unless these Articles of Association require a different majority.
securities	Shares and debt obligations of every kind, and options, warrants and rights to acquire shares or debt obligations.
surplus	The excess, if any, at the time of the determination of the total assets of the Company over the aggregate of its total liabilities, as shown in its books of account, plus the Company's capital.
the Memorandum	The Memorandum of Association of the Company as originally registered or as from time to time amended.
the Ordinance	The Companies Ordinance including any modification, extension, re-enactment or renewal thereof and any regulations made thereunder.
the Seal	Any Seal which has been duly adopted as the Seal of the Company.

**these Articles
treasury shares**

These Articles of Association as originally registered or as from time to time amended.
Shares in the Company that are not issued or that were previously issued but were redeemed.

"Written" or any term of like import includes words typewritten, printed, painted, engraved, lithographed, photographed or represented or reproduced by any mode of representing or reproducing words in a visible form, including telecopier, telex, telegram, cable, e-mail or other form of writing produced by electronic communication.

Save as aforesaid, any words or expressions defined in the Ordinance shall bear the same meaning in these Articles.

Whenever the singular or plural number, or the masculine, feminine or neutral gender is used in these Articles, it shall, where the context admits, include the others.

A reference in these Articles to voting in relation to shares shall be construed as a reference to voting by members holding the shares except that it is the votes allocated to the shares that shall be counted and not the number of members who actually voted, and a reference to shares being present at a meeting shall be given a corresponding construction.

A reference to money in these Articles is a reference to the currency of the United States of America unless otherwise stated.

REGISTERED SHARES

2. The Company shall issue to every member holding registered shares in the Company a certificate signed by a director or officer of the Company under the Seal of the Company specifying the number and type of share or shares held by him, and the signature of the director or officer and the Seal may be facsimiles. The share certificates need to bear separate distinctive numbers.
3. Any member receiving a share certificate for registered shares shall indemnify and hold the Company and its directors and officers harmless from any loss or liability which it or they may incur by reason of wrongful or fraudulent use or representation made by any person by virtue of the possession thereof. If a share certificate for registered shares is worn out or lost, it may be renewed on production of the worn out certificate or on satisfactory proof of its loss, together with such indemnity as may be required by a resolution of directors and by the share transfer agent of the Company.
4. If several persons are registered as joint holders of any shares, any one of such persons may give an effectual receipt for any dividend payable in respect of such shares.

SHARES, AUTHORISED CAPITAL AND CAPITAL

5. Subject to the provisions of these Articles and any resolution of members the unissued shares of the Company shall be at the disposal of the directors who may without prejudice to any rights previously conferred on the holders of any existing shares or class or series of shares, offer, allot, grant options over or otherwise dispose of the shares to such persons, at such times and upon such terms and conditions as the Company may by resolution of directors determine.
6. Shares in the Company shall be issued for money, services rendered, personal property, an estate in real property, a promissory note or other binding obligation to contribute money or property or any combination of the foregoing as shall be determined by a resolution of directors.
7. Shares in the Company may be issued for such amount of consideration as the directors may from time to time by resolution of directors determine, except that in the case of shares with par value, the amount shall not be less than the par value, and in the absence of fraud the decision of the directors as to the value of the consideration received by the Company in respect of the issue is conclusive unless a question of law is involved. The consideration in respect of the shares constitutes capital to the extent of the par value and the excess constitutes surplus.
8. A share issued by the Company upon conversion of, or in exchange for, another share or a debt obligation or other security in the Company, shall be treated for all purposes as having been issued for money equal to the consideration received or deemed to have been received by the Company in respect of the other share, debt obligation or security.
9. Treasury shares may be disposed of by the Company on such terms and conditions (not otherwise inconsistent with these Articles) as the Company may by resolution of directors determine.
10. The Company may issue fractions of a share and a fractional share shall have the same corresponding fractional liabilities, limitations, preferences, privileges, qualifications, restrictions, rights and other attributes of a whole share of the same class or series of shares.

11. Upon the issue by the Company of a share without par value, if an amount is stated in the Memorandum to be authorised capital represented by such shares then each share shall be issued for no less than the appropriate proportion of such amount which shall constitute capital, otherwise the consideration in respect of the share constitutes capital to the extent designated by the directors and the excess constitutes surplus, except that the directors must designate as capital an amount of the consideration that is at least equal to the amount that the share is entitled to as a preference, if any, in the assets of the Company upon liquidation of the Company.
12. The Company may redeem its own shares but only out of surplus or in exchange for newly issued shares of equal value but no redemption shall be made unless the directors determine that immediately after the redemption the Company will be able to satisfy its liabilities as they become due in the ordinary course of its business and the realisable value of the assets of the Company will not be less than the sum of its total liabilities, other than deferred taxes, as shown in the books of account, and its capital and, in the absence of fraud, the decision of the directors as to the realisable value of the assets of the Company is conclusive, unless a question of law is involved. The Company may trade in its own shares, and in the shares of its subsidiary and affiliated companies without restriction as long as the directors determine that such trades are in the best interests of the members of the Company.
13. A determination by the directors under the preceding Article is not required where shares are redeemed
 - a) pursuant to a right of a member to have redeemed or to have his shares exchanged for money or other property of the Company;
 - b) by virtue of the provisions of Section 147 of the Ordinance; or
 - c) pursuant to an order of the court.
14. Shares that the Company redeems or repurchases pursuant to Article 12 may be cancelled or held as treasury shares unless the shares are redeemed out of capital and would otherwise infringe upon the requirements of Article 29, or to the extent that such shares are in excess of 80 percent of the issued shares of the Company, in which case they shall be cancelled but they shall be available for reissue.
15. Upon the cancellation of a share, the amount included as capital of the Company with respect to that share shall be deducted from the capital of the Company.

LIEN

16. The Company shall have a lien on every share, whether fully paid or not, and whether registered in the name of one or more members, and accordingly in Regulation 7 of Table 'A' the words "not being fully paid share" and "other than fully paid shares" shall be omitted; and the words "a single person" shall be deleted and the words "any member, whether alone or jointly with other members" shall be substituted therefor.

TRANSFER OF SHARES

17. Subject to any limitations in the Memorandum, registered shares in the Company may be transferred in such manner as the directors may from time to time decide, including that a professional share transfer agent be retained to maintain the share registry and transfer shares on behalf of the Company.
18. The Company shall not be required to treat a transferee of a registered share in the Company as a member until the transferee's name has been entered in the share register.
19. Subject to any limitations in the Memorandum, the Company must on the application of the transferor or transferee of a registered share in the Company enter in the share register the name of the transferee of the share save that the registration of transfers may be suspended and the share register closed at such times and for such periods as the Company may from time to time by resolution of directors determine provided always that such registration shall not be suspended and the share register closed for more than 60 days in any period of 12 months.

TRANSMISSION OF SHARES

20. The executor or administrator of a deceased member, the guardian of an incompetent member or the trustee of a bankrupt member shall be the only person recognised by the Company as having any title to his share but they shall not be entitled to exercise any rights as a member of the Company until they have proceeded as set forth in Articles 21, 22 and 23.
21. The production to the Company, or its transfer agent, of any document which is evidence of probate of the will, or letters of administration of the estate, or confirmation as executor, of a deceased member or of the appointment of a guardian of an incompetent member or the trustee of a bankrupt member shall be accepted by the Company even if the deceased, incompetent or bankrupt member is domiciled outside Gibraltar if the document evidencing the grant of probate or letter of administration, confirmation as executor, appointment as guardian or trustee in bankruptcy is issued by a foreign court which has competent jurisdiction in the matter. For the purpose of establishing whether or not a foreign court is of competent jurisdiction the directors may obtain appropriate legal advice. The directors may also require an indemnity to be given by the executor, administrator, guardian or trustee in bankruptcy.

22. Any person becoming entitled by operation of law or otherwise to a share or shares in consequence of the death, incompetence or bankruptcy of any member may be registered as a member upon such evidence being produced as may reasonably be required by the directors. An application by any such person to be registered as a member shall for all purposes be deemed to be a transfer of shares and the directors shall treat it as such.
23. Any person who has become entitled to a share or shares in consequence of the death, incompetence or bankruptcy of any member may, instead of being registered himself, request in writing that some person to be named by him be registered as the transferee of such share or shares and such request shall likewise be treated as if it were a transfer.
24. What amounts to incompetence on the part of a person is a matter to be determined by the court having regard to all the relevant evidence and the circumstances of the case.

REDUCTION OR INCREASE IN AUTHORISED CAPITAL OR CAPITAL

25. Subject to the provisions of Article 31, the Company may in General Meeting amend the Memorandum to increase its authorised capital and in connection therewith the Company may in respect of any unissued shares increase the number of such shares and increase the par value of any such shares or effect any combination of the foregoing.
26. The Company may by Special Resolution amend the Memorandum to reduce its authorised capital and in connection therewith the Company may in respect of any unissued shares reduce the number of such shares, reduce the par value of any such shares or effect any combination of the foregoing.
27. Subject to the provisions of Article 31, the Company may amend the Memorandum to
 - a) divide the shares, including issued shares, of a class or series into a larger number of shares of the same class or series; or
 - b) combine the shares, including issued shares, of a class or series into a smaller number of shares of the same class or series,
 provided, however, that where shares are divided or combined under a. or b. of this Article, the aggregate par value of the new shares must be equal to the aggregate par value of the original shares.
28. Subject to the provisions of Article 31, the capital of the Company may in General Meeting be increased by transferring an amount of the surplus of the Company to capital.
29. Subject to the provisions of Articles 30 and 31 the capital of the Company may by special resolution be reduced by:
 - a) returning to members any amount received by the Company upon the issue of any of its shares, the amount being surplus to the requirements of the Company; or
 - b) cancelling any capital that is lost or not represented by assets having a realisable value; or
 - c) transferring capital to surplus for the purpose of redeeming shares that the directors have resolved to redeem.
30. No reduction of capital shall be effected that reduces the capital of the Company to an amount that immediately after the reduction is less than the aggregate par value of all outstanding shares with par value and all shares with par value held by the Company as treasury shares and the aggregate of the amounts designated as capital of all outstanding shares without par value and all shares without par value held by the Company as treasury shares that are entitled to a preference, if any, in the assets of the Company upon liquidation of the Company.
31. The capital or authorised capital of the Company can only be increased beyond 10,000,000 shares by a two-thirds (2/3) approval of not less than 75% of the total outstanding shares of the Company voting at a meeting of the members.

MEETINGS AND CONSENTS OF MEMBERS

32. The Annual General Meeting of the members shall be held at such time and place in each year, as the Board of Directors shall from time to time determine.
33. Other meetings of members may be convened
 - a) by order of the President and/or of the Chief Executive Officer (CEO); or
 - b) by the affirmative vote of a majority of the Board of Directors; or
 - c) by a member or members who own twenty percent or more of the voting shares of the Company.
 Meetings will be held at such times and in such manner and places within or outside Gibraltar as the directors consider necessary or desirable.
34. The directors shall give not less than 21 days notice of meetings of members to those persons whose names, on the Record Date of the meeting, appear as members in the share register of the Company.
35. The directors may fix a date of not more than 60 days in advance of a meeting of members as the Record Date for determining those shares that are entitled to vote at the meeting.
36. The inadvertent failure of the directors to give notice of a meeting to a member, or the fact that a member has not received notice, does not invalidate the meeting.

37. A member may be represented at a meeting of members by a proxy who may speak and vote on behalf of the member.
38. The instrument appointing a proxy shall be produced at the place appointed for the meeting, or at such place or places as the directors shall appoint, before the time for holding the meeting at which the person named in such instrument proposes to vote.
39. An instrument appointing a proxy shall be in substantially the following form or such other form as the Chairman of the meeting shall accept as properly evidencing the wishes of the member appointing the proxy.

[COMPANY NAME]

I/We being a member of the above Company with shares HEREBY APPOINT..... of to be my/our proxy to vote for me/us at the meeting of members to be held on theday of the month ofin the year..... and at any adjournment thereof.

Signed this... day of the month ofin the year.....

.....
Member

40. At any meeting of the members, beneficial owners of shares may vote those shares to which they have beneficial ownership where the direct owner of the shares is not voting those shares, when such beneficial ownership is supported by documentary evidence. This evidence may be a broker's statement or other credible documentation acceptable to the directors of the Company.
41. The following shall apply in respect of joint ownership of shares
 - a) if two or more persons hold shares jointly each of them may be present in person or by proxy at a meeting of members and may speak as a member;
 - b) if only one of the joint owners is present in person or by proxy he may vote on behalf of all joint owners; and
 - c) if two or more of the joint owners are present in person or by proxy they must vote as one.
42. A member shall be deemed to be present at a meeting of members if he participates by telephone or e-mail or other electronic means and all members participating in the meeting are able to communicate with one another.
43. A meeting of members is duly constituted if, at the commencement of the meeting, there are present in person or by proxy or by telephone or by e-mail or other electronic means not less than 20 percent of the votes of the shares or class or series of shares entitled to vote on resolutions of members to be considered at the meeting.
44. If within two hours from the time appointed for the meeting a quorum is not present, the meeting, if convened upon the requisition of members, shall be dissolved; in any other case it shall stand adjourned to the next business day at the same time and place or to such other time and place as the directors may determine, and if at the adjourned meeting there are present within one hour from the time appointed for the meeting in person or by proxy or by telephone or by e-mail or other electronic means not less than 20 percent of the votes of the shares or each class or series of shares entitled to vote on the resolutions to be considered by the meeting, those present shall constitute a quorum but otherwise the meeting shall be dissolved.
45. At every meeting of members, the Chairman of the Board of Directors shall preside as chairman of the meeting. If there is no Chairman of the Board of Directors or if the Chairman of the Board of Directors is not present at the meeting, the members present shall choose one of their number to be the chairman. If the members are unable to choose a chairman for any reason, then the person representing the greatest number of voting shares present in person or by prescribed form of proxy at the meeting shall preside as chairman, failing which the oldest individual member or representative of a member present shall take the chair.
46. The chairman may, with the consent of the meeting, adjourn any meeting from time to time, and from place to place, but no business shall be transacted at any adjourned meeting other than the business left unfinished at the meeting from which the adjournment took place.
47. At any meeting of the members the chairman shall be responsible for deciding in such manner as he shall consider appropriate whether any resolution has been carried or not and the result of his decision shall be announced to the meeting and recorded in the minutes thereof. If the chairman shall have any doubt as to the outcome of any resolution put to the vote, he shall cause a poll to be taken of all votes cast upon such resolution, but if the chairman shall fail to take a poll then any member present in person or by proxy who disputes the announcement by the chairman of the result of any vote may immediately following such announcement demand that a poll be taken and the chairman shall thereupon cause a poll to be taken. If a poll is taken at any meeting, the result thereof shall be duly recorded in the minutes of that meeting by the chairman.

48. Any person other than an individual shall be regarded as one member and subject to Article 40 the right of any individual to speak for or represent such member shall be determined by the law of the jurisdiction where, and by the documents by which, the person is constituted or derives its existence. In case of doubt, the directors may in good faith seek legal advice from any qualified person and unless and until a court of competent jurisdiction shall otherwise rule the directors may rely and act upon such advice without incurring any liability to any member.
49. Any person other than an individual which is a member of the Company may by resolution of its directors or other governing body authorise such person as it thinks fit to act as its representative at any meeting of the Company or of any class of members of the Company, and the person so authorised shall be entitled to exercise the same powers on behalf of the person which he represents as that person could exercise if it were an individual member of the Company.
50. The chairman of any meeting at which a vote is cast by proxy or on behalf of any person other than an individual may call for a notarially certified copy of such proxy or authority which shall be produced within 7 days of being so requested or the votes cast by such proxy or on behalf of such person shall be disregarded.
51. Directors of the Company may attend and speak at any meeting of members of the Company and at any separate meeting of the holders of any class or series of shares in the Company.
52. An action that may be taken by the members at a meeting may also be taken by a resolution of members, representing not less than 75 percent of the votes of the shares or class or series of shares entitled to vote on resolutions of members, consented to in writing or by telex, telegram, cable, facsimile, e-mail or other written electronic communication, without the need for any notice, but if any resolution of members is agreed otherwise than by the unanimous written consent of all represented members, then said resolution shall have no standing, and shall not be adopted.

DIRECTORS

53. The members of the Board shall be divided into three classes, the classes to be as nearly equal in number as possible. The term of office of the directors of the first class shall expire at the first annual meeting of members after their election, that of the second class shall expire at the second annual meeting after their election, and that of the third class to expire at the third annual meeting after their election. At each annual general meeting of the members following the adoption of these articles, the successors to the class of directors whose term expires at that meeting shall be elected to hold office for a term expiring at the annual meeting of members held in the third year following the year of their election and until their successors have been elected and qualified.
54. The minimum number of directors shall be five and the maximum number shall be fifteen.
55. Each director shall hold office for the term, if any, fixed by resolution of members or until his earlier death, resignation or removal.
56. The members may from time to time, by affirmative vote of two-thirds (2/3) of shares entitled to vote at a general meeting of members, remove any director or directors for cause before the expiration of his or their period of office and elect any qualified person or persons in his or their stead for the balance of his or their term at a general meeting of members, of which notice specifying the intention to pass such resolution shall have been given.
57. A director may resign his office by giving written notice of his resignation to the Company and the resignation shall have effect from the date the notice is received by the Company or from such later date as may be specified in the notice.
58. The office of a director shall be vacated
 - a) if he is adjudged bankrupt;
 - b) if he becomes of unsound mind;
 - c) if he is absent from the meetings of the directors for six months without the leave of the other directors or a majority of the other directors;
 - d) if he resigns by notice in writing left at or sent to the office of the Company; or
 - e) if he becomes prohibited by law from acting as a director.
59. A vacancy in the Board of Directors may be filled by a resolution of members or by a resolution of not less than two-thirds (2/3) of the remaining directors.
60. With the prior or subsequent approval by a resolution of members, the directors may, by a resolution of directors, fix the emoluments of directors with respect to services to be rendered in any capacity to the Company.

POWERS OF DIRECTORS

61. The business and affairs of the Company shall be managed by the directors who may exercise all such powers of the Company as are noted by the Ordinance or by the Memorandum or these Articles required to be exercised by the members of the Company, subject to any delegation of such powers as may be authorised by these Articles and to such requirements as may be prescribed by a resolution of members; but no requirement made by a resolution of members shall prevail if it be inconsistent with these Articles nor shall such requirement invalidate any prior act of the directors which would have been valid if such requirement had not been made.
62. All actions taken and things done by any meeting of persons acting as a Board of Directors or by any person acting as a director shall, notwithstanding that it shall afterwards be discovered that there was some defect in the election, appointment or qualification of such Board or director, be as valid as though such defect had not obtained.
63. The directors may, by a resolution of directors, appoint any person, including a person who is a director, to be an officer or agent of the Company.
64. Every officer or agent of the Company has such powers and authority of the directors, including the power and authority to affix the Seal, as are set forth in these Articles or in the resolution of directors appointing the officer or agent, except that no officer or agent has any power or authority with respect to fixing the emoluments of directors.
65. Any director which is a body corporate may appoint any person its duly authorised representative for the purpose of representing it at meetings of the Board of Directors or with respect to unanimous written consents.
66. The continuing directors may act notwithstanding any vacancy in their body, save that if their number is reduced below the number fixed by or pursuant to these Articles as the necessary quorum for a meeting of directors, the continuing directors or director may act only for the purpose of appointing directors to fill any vacancy that has arisen for summoning a meeting of members.
67. All cheques, promissory notes, drafts, bills of exchange and other negotiable instruments and all receipts for moneys paid to the Company, shall be signed, drawn, accepted, endorsed or otherwise executed, as the case may be, in such manner as shall from time to time be determined by resolution of directors.

PROCEEDINGS OF DIRECTORS

68. The directors of the Company or any committee hereof may meet at such times and in such manner and places within or outside Gibraltar as the directors may determine to be necessary or desirable, including a continuous on-line meeting conducted by e-mail or other electronic means.
69. A director shall be deemed to be present at a meeting of directors if he participates by telephone or e-mail or other electronic means and all directors participating in the meeting are able to communicate with one another.
70. A director shall be given not less than 48 hours notice of meetings of directors, for any meeting other than the continuous on-line meeting conducted by e-mail or other electronic means, but a meeting of directors held without 48 hours notice having been given to all directors shall be valid if all the directors entitled to vote at the meeting who do not attend, waive notice of the meeting and for this purpose, the presence of a director at a meeting shall constitute waiver on his part. The inadvertent failure to give notice of a meeting to a director, or the fact that a director has not received the notice, does not invalidate the meeting.
71. A director may by a written instrument appoint an alternate, who need not be a director, and an alternate is entitled to attend meetings in the absence of the director who appointed him and to vote or consent in place of the director.
72. A meeting of directors is duly constituted for all purposes if at the commencement of the meeting there are present in person or by alternate or by telephone or by e-mail or other electronic means not less than two-thirds (2/3) of the total number of directors, unless there are only two directors in which case the quorum shall be two.
73. At every meeting of the directors the Chairman of the Board of Directors shall preside as chairman of the meeting. If there is no Chairman of the Board of Directors or if the Chairman of the Board of Directors is not present at the meeting the Vice-Chairman of the Board of Directors shall preside. If there is no Vice Chairman of the Board of Directors or if the Vice Chairman of the Board of Directors is not present at the meeting the directors present shall choose some one of their number to be chairman of the meeting.
74. An action that may be taken by the directors or a committee of directors at a meeting may also be taken by a resolution of directors or a committee of directors consented to in writing or by telex, telegram, cable, facsimile, e-mail, or other written electronic communication by all directors or all members of the committee as the case may be, without the need for any notice.

75. The directors shall cause the following corporate records to be kept
- a) minutes of all meetings of directors, members, committees of directors, committees of officers and committees of members;
 - b) copies of all resolutions consented to by directors, members, committees of directors, committees of officers and committees of members; and
 - c) such other accounts and records as the directors by resolution of directors consider necessary or desirable in order to reflect the financial position of the Company.
76. The books, records and minutes shall be kept at the registered office of the Company in Gibraltar and at such other place or offices as the directors determine. These shall be open for inspection by any member of the Board at all reasonable business hours.
77. The Board of Directors shall have a Chairman, an Executive Committee, an Audit Committee and a Compensation Committee, and as many other committees of the Board of Directors, as the directors may deem appropriate.
78. Each committee of directors has such powers and authorities of the directors, including the power and authority to affix the Seal, as are set forth in the resolution of directors establishing the committee, except that no committee has any power or authority to amend the Memorandum or these Articles.
79. The Executive Committee shall have no less than three members and no more than five. The Board of Directors elects the Executive Committee after each Annual Meeting. The Executive Committee has the authority to function for the full Board of Directors and can bind the Company, subject to the full Board of Directors and Regulatory Approvals where appropriate. The Executive Committee is for ease of operation, although the deliberations of Executive Committee are carried out in electronic communications to which all directors are privy.
80. The meetings and proceedings of each committee of directors consisting of two or more directors shall be governed mutatis mutandis by the provisions of these Articles regulating the proceedings of directors so far as the same are not superseded by any provisions in the resolution establishing the committee.

FINANCING

81. The Board of Directors may from time to time
- a) borrow money upon the credit of the Company;
 - b) limit or increase the amount to be borrowed;
 - c) issue shares in the Company subject to the following: The share capitalization of the Company is limited to 5,000,000 shares outstanding. This can be changed only by a two-thirds (2/3) approval of not less than 75% of the total outstanding shares of the Company voting at a meeting of the members.
 - d) repurchase or borrow Company shares, directly or indirectly and sell, trade or use them in any manner to finance the Company, subject to the reporting requirements in the jurisdictions where the shares trade and to the laws of Gibraltar. The Company has the right to sell shares, debentures or other securities in subsidiary or directly or indirectly controlled companies for such sums and at such prices as may be deemed expedient, subject to the reporting requirements in the jurisdictions where the shares trade and to the laws of Gibraltar;
 - e) secure any such shares or debentures or other securities in subsidiary companies or directly or indirectly controlled companies or any other present or future borrowing or liability of subsidiary or directly or indirectly controlled companies of the Company by mortgage, charge or pledge of all or any currently owned or subsequently acquired real and personal, movable or immovable property directly or indirectly owned; and
 - f) pay commission for financing or sales of shares or properties or interests that benefit the Company or its subsidiary or directly or indirectly controlled companies.
82. The Board of Directors may from time to time authorize any director or directors, officer or officers, employee or agents of the Company, or other person or persons, whether connected with the Company or not, to make arrangements for the Company, and its subsidiary companies, and directly and indirectly controlled companies, with references to the money borrowed, or to be borrowed as aforesaid, and as to the terms and conditions of the loan thereof, and with the power to vary or modify such arrangements, terms and conditions and to give such additional securities.
83. The Company may borrow money from officers and directors and others for its ongoing business needs on such terms and conditions as the directors may from time to time authorize.
84. The Board of Directors may from time to time authorize any director or directors, officer or officers, employee or agents of the Company, or other person or persons, whether connected with the Company or not, to sign, execute and give on behalf of the Company, and its subsidiary companies, and directly and indirectly controlled companies, all documents, agreements, promises and other writings necessary or desirable for the purposes aforesaid to draw, make, accept, endorse, execute and issue cheques, wire transfers, money orders, purchases and sales of securities, promissory notes, bills of exchange, bills of lading, and other negotiable or transferable instruments, and the same and all renewals thereof or substitutions thereof so signed shall be binding upon the Company.

85. The powers hereby conferred shall be and be deemed to be in supplement of, and not in substitution for, any powers to borrow money, or conduct business for the purposes of the Company possessed by its directors or officers:
86. The Directors shall cause a proper register to be kept in accordance with the Ordinance of all mortgages and charges specifically affecting the property of the Company and shall duly comply with the requirements of the Ordinance in relation and otherwise.

OFFICERS

87. The officers of the Company shall be a President, a Chief Executive Officer (CEO), a Secretary and such other officers as the Board in its discretion may from time to time elect. The President and/or the CEO may from time to time appoint persons who are not corporate officers to executive or administrative offices, with such titles as the President and/or the CEO in his/their discretion may determine.
88. Any offices except those of President and Secretary may be held by the same person.
89. The officers shall perform such duties as shall be prescribed at the time of their appointment subject to any modification in such duties as may be prescribed thereafter by resolution of directors or resolution of members.
90. The remuneration of all officers of the Company shall be established by the Compensation Committee of the Board in such manner as it may from time to time determine.
91. The officers of the Company shall hold office until their successors are duly elected and qualified, but any officer elected or appointed by the directors may be removed at any time, with or without cause, by resolution of directors. Any vacancy occurring in any office of the Company may be filled by resolution of directors.
92. Except to the extent from time to time otherwise determined by resolution of the Board, the President and the CEO shall be the Executive Officers of the Company and shall have general supervision of all other officers and their duties.
93. Subject to any statutory limitation, the President and/or the CEO may from time to time delegate to any other person the powers, authority and duties of any officer.
94. Subject to such limitation as the Board may from time to time impose, an officer shall have all the powers and authority and shall perform all the duties as may from time to time be imposed upon the holder of such office by the Articles of Association of the Company or by resolution of the Board.

CONFLICT OF INTERESTS

95. If a director, officer or employee of the Company is a director or officer of another company or holds a beneficial interest of 5% or more, directly or indirectly, in a company or property, such other company or property may not be vended into the Company unless
- a) the terms of such contract are fully disclosed in advance to the Board of Directors of the Company; and
 - b) if the cost to the Company exceeds \$50,000 USD, then the contract must be approved by a two-thirds (2/3) majority of the Board of Directors, with the director or directors involved abstaining; and
 - c) if the cost to the Company exceeds \$200,000 USD then the contract must be ratified by two-thirds (2/3) of the members of the Company in attendance at a regular or special meeting of members called to consider the subject contract.
- These restrictions do not apply to the provision of goods and services in the ordinary course of business.

INDEMNIFICATION

96. No director shall be disqualified by his office or by reason of holding any other office or place of profit under the Company or under any company in which the Company shall be a shareholder or otherwise interested from entering into any contract or arrangement with the Company as a provider of goods and services in the ordinary course of business; nor shall any such contract or arrangement be thereby avoided; nor shall any director be liable to account to the Company for any profit arising from any such contract or arrangement; nor shall any director be liable to account to the Company for any profit arising from any such office or place of profit or realized by any such contract or arrangement, subject to Article 95. Subject to any statutory requirement, every Director shall be obligated to make relevant disclosure of all such interests and shall refrain from voting on all issues involving such interests.
97. No director or Officer of the Company, while in office and acting in his official capacity shall be liable for: the acts, receipts, neglects or defaults of any other person; or for joining in any receipt or act of conformity; or for any loss, damage or expense happening to the Company through the insufficiency or deficiency of title to any property acquired by, for or on behalf of the Company; or for the insufficiency or deficiency of any security in or upon which any moneys of the Company are invested; or for any loss or damages arising from the bankruptcy, insolvency or tortious act of any person with whom any moneys, securities, or other property of the Company are lodged or deposited; or for any other loss, damage, or misfortune whatever which may arise out of the execution of the duties of his office or in relation thereto unless the same shall happen by or through his own willful and wrongful act.

98. Any contract entered into or action taken or omitted by or on behalf of the Company shall, if approved by a resolution of the members in General Meeting, be deemed for all purposes to have had prior authorization of its members.
99. The Company may purchase and maintain insurance in relation to any person who is or was a director, or an officer of the Company, or who at the request of the Company is or was serving as a director, or an officer of, or in any other capacity is or was acting for another company or a partnership, joint venture, trust or other enterprise, against any liability asserted against the person and incurred by the person in that capacity, whether or not the Company has or would have had the power to indemnify the person against the liability. The Company may purchase and maintain life insurance in relation to any person who is or was a director, or an officer of the Company, or serving as a consultant to the Company, in any amount with the Company as a primary beneficiary.

SEAL

100. The Seal, an impression whereof is stamped on the margin hereof, shall be the Seal of the Company.

101. The Company may have more than one seal and references herein to the Seal shall be references to every seal which shall have been duly adopted by resolution of directors. The directors shall provide for the safe custody of the Seal and for an imprint thereof to be kept at the Registered Office. Except as otherwise expressly provided herein the Seal when affixed to any written instrument shall be witnessed and attested to by the signature of a director or any other person so authorised from time to time by resolution of directors. Such authorisation may be before or after the Seal is affixed, may be general or specific and may refer to any number of sealings. The directors may provide for a facsimile of the Seal and of the signature of any director or authorised person which may be reproduced by printing or other means on any instrument and it shall have the same force and validity as if the Seal had been affixed to such instrument and the same had been signed as hereinbefore described.

MERGER/ACQUISITION

102. In the event that two-thirds (2/3) of the entire Board of Directors shall approve the acquisition of the Company by any individual, group of individuals or business entity, or the merger of the Company with any other business entity, such approval shall become effective upon ratification by not less than two-thirds (2/3) of the outstanding shares of the Company entitled to vote at a meeting of the members of the Company especially called for such purpose.
103. In the event that any such acquisition or merger of the Company shall not be approved by the Board of Directors as set forth above, then such disapproval may be over-ridden by an affirmative vote of not less than three-quarters (3/4) of the total outstanding shares at a meeting of members of the Company specially called for such purpose.

DIVIDENDS

104. Dividends shall be payable from time to time only to the extent and as and when and in what manner the Board of Directors, at its discretion, may from time to time determine.
105. Subject to any applicable statutory provisions, the Board may fix in advance a date preceding, by not more than thirty (30) days, the date for payment of any dividend or share distribution or any other form of distribution to the members, as a Record Date for the determination of the rights to receive the distribution as the case may be and in every such case only such persons as shall be members of record at the close of business on the date so fixed shall be entitled to receive payment of such dividend or distribution, notwithstanding the transfer of any shares after any such Record Date fixed as aforesaid.
106. If the dividend or distribution which has been declared is payable in cash, then it shall be paid by cheque drawn to the order of each registered holder of shares of the Company as of the Record Date fixed, and mailed with postage prepaid to such registered holder at his address as recorded on the books of the Company, unless such holder otherwise directs. In the case of joint holders, the cheque shall, unless such joint holders otherwise direct, be made payable to the order of all of such holders and if more than one address is recorded on the books of the Company in respect to such joint holding, the cheque shall be mailed to the first address so recorded. The mailing of such a cheque as the aforesaid shall satisfy and discharge all liability for the dividend to the extent of the sum presented thereby, unless such cheque is not paid upon due presentation. In the event of non-receipt of any dividend cheque thereby the person to whom it is so sent at aforesaid address, the Company shall issue or cause to be issued to such person a replacement cheque for the like amount upon such terms as to indemnify the Company and such evidence of non-receipts as the President and/or the CEO may from time to time prescribe, whether generally or in any particular case.

WITHHOLDING INFORMATION FROM MEMBERS

107. No member shall be entitled by virtue of being a member to discovery of any information or records respecting the Company or its business except under authority which may be general or specific of a Resolution of the Board, saving always the statutory rights of a member.

ACCOUNTS

108. The books of account if any shall be kept at the registered office of the Company, or at such other place or places as the directors deem fit.
109. The directors may, if they deem it fit, cause to be made out and may serve on the members or lay before a meeting of members a profit and loss account for a period in the case of the first account since the incorporation of the Company and in any other case, since the preceding account, made to a date not earlier than the date of the notice by more than twelve months, and a balance sheet as at the date to which the profit and loss account is made up.
110. Copies of any such profit and loss account and balance sheet shall be made available to every member of the Company.
111. The accounts of the Company are to be kept in accordance with the provisions of generally accepted accounting practices in Gibraltar.
112. The directors shall, in accordance with the Ordinance cause to be made out in every year and to be laid before the Company in General Meeting a balance sheet and profit and loss account to be decided upon by the directors and made up to a date not earlier than the date of the Meeting by more than nine months.

AUDIT

113. The Company may by resolution of members call for the accounts to be examined by auditors.
114. The first auditors shall be appointed by resolution of directors; subsequent auditors shall be appointed by a resolution of members and his duties regulated in accordance with the Ordinance.
115. The auditors shall examine each profit and loss account and balance sheet required to be made available to every member of the Company or laid before a meeting of the members of the Company and shall state in a written report whether or not
- a) in their opinion the profit and loss account and balance sheet give a true and fair view respectively of the profit and loss for the period covered by the accounts, and of the state of affairs of the Company at the end of that period;
 - b) all the information and explanations required by the auditors have been obtained.
116. The report of the auditors shall be annexed to the accounts and shall be presented at the meeting of members at which the accounts are laid before the Company or shall be otherwise made available to members.
117. Every auditor of the Company shall have a right of access at all times to the books of account and vouchers of the Company, and shall be entitled to require from the directors and officers of the Company such information and explanations as he thinks necessary for the performance of the duties of the auditors.
118. The auditors of the Company shall be entitled to receive notice of, and to attend any meetings of members of the Company at which the Company's profit and loss account and balance sheet are to be presented.

SECRETARY

119. A Secretary shall be appointed by the directors for such term, at such remuneration and upon such conditions as they may think fit; and any Secretary so appointed may be removed by them.

NOTICES

120. Any notice, information or written statement to be given by the Company to members must be served to the physical address or the e-mail address of such shareholder appearing on the books of the Company or, if not so appearing, to the last physical and/or e-mail address known to the person charged with serving such notice, and for such purpose the address of any shareholder on the books of the Company may be changed in accordance with any information which appears to be reliable: and any notice with respect to shares registered in the names of more than one person shall be given to whichever of such persons is named first in the share register and notice so given shall be sufficient notice to all holders thereof.
121. Any summons, notice, order, document, process, information or written statement to be served on the Company may be served by leaving it, or by sending it by registered mail addressed to the Company, at its registered office.
122. Service of any summons, notice, order, document, process, information or written statement to be served on the Company may be proved by showing that the summons, notice, order, document, process, information or written statement was mailed in such time as to admit to its being delivered in the normal course of delivery within the period prescribed for service and was correctly addressed and the postage was prepaid.

123. Any notice or other communication delivered in person shall be deemed to have been given at the time of delivery, and any notice or other communications sent by Air Mail or Registered Post shall be deemed to have been given on the day of mailing, and any notice or other communication sent by any means or wire or wireless including e-mail and fax or any form or recorded communication shall be deemed to have been given the day when it was sent electronically, and any communication delivered by Courier shall be deemed to have been given on the day it was delivered to the appropriate agency for dispatch; and a certificate in respect of any thereof in writing signed by any officer of the Company or by an agent of the Company shall be conclusive evidence of the matters therein certified.
124. Every person who by any means whatsoever becomes entitled to any share shall be bound by every notice in respect thereof given to his predecessor in title to the name and address of such person being entered in the share register of the holder thereof.
125. Any notice or other communication duly given to any member shall, notwithstanding that such member be then deceased and whether or not the Company have notice thereof, be deemed to have been duly served upon all persons, including his heirs, executors, administrator or assigns, having any title to or interest in the shares registered in the name of such member either as sole holder or as holder thereof jointly with others.
126. The signature to any notice or other communication to be given by the Company may be in whole or in part written, stamped, typewritten, electronically signed, e-mailed, printed or done in any other consistent verifiable manner.
127. The accidental omission to send any notice to any member, director, officer or auditors or the non-receipt of any notice by any member, director, officer or auditors or any error in the notice not affecting the substance thereof shall not invalidate any action taken at any meeting held pursuant to such notice or otherwise founded thereon.
128. Any member, director, officer or auditors may waive any notice requirement to be given by the Articles or Memorandum or by statute, and such waiver whether given before or after the meeting or other event of which notice is required to be given shall cure any default in the giving of such notice.

VOLUNTARY WINDING UP AND DISSOLUTION

129. Subject to any rights which may exist in favour of any particular class of shares, if the Company shall be insufficient to repay the whole of the paid up capital, such assets shall be distributed, so that as nearly as may be, the deficiency shall be born by the members in proportion to the capital paid up or nearly as may be, the deficiency shall be born by the members in proportion to the capital paid up or which ought to have been paid up at the commencement of the winding up of the shares held by them respectively, and if on a winding up, the assets available for distribution among the members shall be more than sufficient to repay the whole of the capital paid up, at the commencement of the winding up, the excess shall be distributed among the members in proportion to the capital at the commencement of the winding up, paid or which ought to have been paid up on the shares held by them respectively.
130. Subject to any rights which may exist in favour of any particular class of shares, but subject to the provisions of any law from time to time in force with regard thereto, any part of the assets of the Company, including any shares in other companies, may be divided among the members of the Company in specie, or may be vested in trustees for the benefit of such members and the liquidation of the Company may be closed and the Company dissolved, but so that no members shall be compelled to accept any shares or otherwise whereon there is any liability.

ENACTED this 25th day of June 2003

For CHORUS MOTORS PUBLIC LIMITED COMPANY,

WITNESS the Corporate
Seal of the Company.

Rodney T. Cox
CEO/Chairman

Isaiah W. Cox
President/COO

BDO Fidecs Management Limited
Corporate Secretaries

List of Authorized Signatories

1. Rodney T. Cox;
2. Isaiah Cox; and
3. Fidecs Management Limited

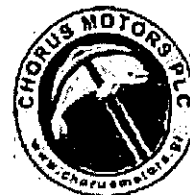

Chorus Motors plc

RECEIVED

2006 JUN 22 A 9:36

GIBRALTAR COMPANY NUMBER 68312
INFORMATION CIRCULAR
Fiscal Year 2006

OFFICE OF INTERNATIONAL
CORPORATE FINANCE

1. SOLICITATION OF PROXIES:

This information circular is furnished in connection with the solicitation of proxies by the Management of Chorus Motors plc ("Company") for use at its Annual Meeting of Members to be held 20 June 2006 in Gibraltar and via the Internet at www.chorusmotors.gi, with the Record Date of the meeting being 4 May 2006, for the purposes set forth in the Notice of Meeting. It is expected that the solicitation will be by mail, e-mail, fax, Internet web site, telephone or in person by Officers and Directors of the Company. The cost of solicitation will be borne by the Company. The information contained herein is given as of 31 March 2006, unless otherwise indicated. All dollar figures set forth are expressed in United States Dollars. All accounting is done in accordance with Gibraltar Generally Accepted Accounting Principles (GAAP).

2. QUORUMS AND VOTING:

The authorised share capital of the Company is \$100,000, consisting solely of one class of common shares divided into 10,000,000 shares with par value of \$0.01 per share, of which 6,573,823 shares were outstanding at the close of business 31 March 2006.

Each holder of record of a common share as of the Record Date for the meeting is entitled to attend the meeting and to cast one vote for each share. Proxies are being accepted by hand delivery, mail, e-mail, fax, and the Company's Internet website at www.chorusmotors.gi. Any resolution to be voted upon at the meeting must be approved by a majority of the votes cast, unless the Company's Articles of Association stipulate a number or proportion of the votes cast in excess of a majority. The meeting will proceed as long as there is a quorum at the meeting place including the voted proxies.

3. REVOCATION OF PROXIES:

Each shareholder has the power to revoke a proxy at any time as long as it has not been exercised. In addition to revocation in any other manner permitted by law, a member giving a proxy pursuant to this solicitation who wishes to revoke the proxy instrument may do so in writing. This revocation must be executed by the member, or by his attorney authorised in writing, or, if the member is a Corporation, under its Corporate seal or by an officer or attorney thereof duly authorised, and received by mailed, or deposited, at any office of the Company, via e-mail to proxy@chorusmotors.gi, or by fax to +44.207.504.3593 at any time up to and including the last business day preceding the day of the meeting, or any adjournment thereof at which the proxy is to be used, or with the Chairman of such meeting on the day of the meeting, or adjournment thereof.

4. PRINCIPAL HOLDERS OF VOTING SHARES:

To the knowledge of the Directors and Officers of the Company there is no person who beneficially owns or exercises control or direction over shares carrying more than ten percent of the votes attached to shares of the Company as of 31 March 2006 except:

Borealis Technical Limited (which is a 98% owned subsidiary of Borealis Exploration Limited) owns 5,202,619 shares, which is 79.20% of the outstanding shares.

5. ELECTION OF DIRECTORS:

Present Directors

Remaining Term

Isaiah W. Cox, A.B.	up for election
Nechama J. Cox, Ph.D.	up for election
Giulio Pontecorvo, Ph.D.	up for election
John Klys	1 year
Wayne S. Marshall, Ph.D.	1 year
Rodney T. Cox, Ph.D.	2 years
Stuart Harbron, Ph.D.	2 years
Peter Vanderwicken, A.B.	2 years

The proxy will be voted for the following proposed nominees (or for a substitute nominee in the event of contingencies not known at present) who will serve for a period of 3 years, or their successors if they are elected or appointed in accordance with the Articles of Association of the Company. Respective reported share totals are as at 31 March 2006.

ISAIAH W. COX became a Director of the Company on 21 December 1999. Mr. Cox is President, Chief Operating Officer, and a member of the Executive Committee and the Compensation Committee of the Company. He is currently also a Director of Borealis Exploration Limited, Borealis Technical Limited, Avto Metals plc, Cool Chips plc, Photon Power plc, Power Chips plc, Roche Bay Holdings Limited, Roche Bay Holdings (Barbados) Limited, Credits Holdings Limited, Borealis Roche Bay Limited, WheelTug plc, Cool Chips Military Sales plc, and Faraway plc. Mr. Cox is a Member of the Council of the Jeremiah Toyam Cox Foundation Limited and the Hart Cox Foundation Limited, among other foundations based in Gibraltar. Isaiah W. Cox beneficially owns directly or indirectly 37,810 shares of Chorus Motors plc.

NECHAMA J. COX became a Director of the Company on 1 August 2001. Dr. Cox is the European Regional Manager of the Company as well as for Borealis Technical Limited, Cool Chips plc and Power Chips plc. Since July 2002, she has directed the Chorus Motors plc research and product development effort. In 1999, she founded the Mishkan School as well as being a Founding Governor of the Noam Primary School. She is currently also a Director of Borealis Exploration Limited, Chorus Motors plc, Cool Chips plc, Photon Power plc and Power Chips plc. She is a Member of the Council of a number of foundations based in Gibraltar. Nechama J. Cox beneficially owns directly or indirectly 13,775 shares of Chorus Motors plc.

THE PRESENT POSITION AND OFFICE WITH THE COMPANY IF APPLICABLE, AND THE PRESENT PRINCIPAL OCCUPATION OR EMPLOYMENT OF THE INCUMBENT DIRECTORS AND OFFICERS ARE AS FOLLOWS. UNLESS OTHERWISE STATED, SUCH OCCUPATION OR EMPLOYMENT HAS CONTINUED FOR MORE THAN THE LAST FIVE YEARS

GIULIO PONTECORVO became a Director of the Company on 28 August 2003. He is a Professor Emeritus at the Columbia University Graduate School of Business, and has served on numerous National Academy of Science committees. Professor Pontecorvo has advised the United Nations, the World Bank and other multilateral organizations on a variety of economic and environmental issues, and has published widely on many economic, financial and environmental topics. Dr. Pontecorvo is currently also a Director of Borealis Exploration Limited, Cool Chips plc, and Power Chips plc. Giulio Pontecorvo beneficially owns directly or indirectly 4,169 shares of Chorus Motors plc.

JOHN KLYS became a director 21 December 1999. Mr. Klys is a business consultant. John Klys beneficially owns directly or indirectly 10,000 shares of Chorus Motors plc.

WAYNE S. MARSHALL became a Director of the Company on 21 December 1999. He retired as a Professor of Business Administration from Long Island University, where he remains an Emeritus Professor. Dr. Marshall is Chairman of the Executive and Compensation Committees, and a member of the Audit Committee of the Company. He is currently also a Director of Borealis Exploration Limited, Borealis Technical Limited, Avto Metals plc, Cool Chips plc, Photon Power plc, Power Chips plc, Roche Bay Holdings Limited, Roche Bay Holdings (Barbados) Limited, Credits Holdings Limited, Borealis Roche Bay Limited, WheelTug plc, Cool Chips Military Sales plc, and Faraway plc. Dr. Marshall is a Member of the Council of the VSBM Foundation Limited, among other foundations based in Gibraltar. Wayne S. Marshall beneficially owns directly or indirectly 29,171 shares of Chorus Motors plc.

RODNEY T. COX became Chief Executive Officer on 18 March 1999. Dr. Cox became a Director and Chairman of the Board of the Company on 21 December 1999. He is a member of the Executive, Audit and Compensation Committees. He was a Partner in The Parmenides Group until February 2000. He is currently also a Director of Borealis Exploration Limited, Borealis Technical Limited, Avto Metals plc, Cool Chips plc, Photon Power plc, Power Chips plc, Roche Bay Holdings Limited, Roche Bay Holdings (Barbados) Limited, Credits Holdings Limited, Borealis Roche Bay Limited, WheelTug plc, Cool Chips Military Sales plc, and Faraway plc. Dr. Cox is a Member of the Council of the Hart Cox Foundation Limited and the Jeremiah Toyam Cox Foundation Limited, among other foundations based in Gibraltar. Rodney T. Cox beneficially owns directly or indirectly 48,165 shares of Chorus Motors plc.

STUART HARBON became a Director of the Company on 23 July 2002. Dr Harbron is Chief Patent Officer for the Company. He is the owner of The Enzyme Technology Consultancy, a consulting business specializing in providing IP intelligence to the biotechnology industry. He is currently also a Director of Avto Metals plc, Borealis Exploration Limited, Cool Chips plc, and Power Chips plc. Dr. Harbron is a Member of the Council of the Edgar Research Foundation. Stuart Harbron beneficially owns directly or indirectly 790 shares of Chorus Motors plc.

PETER VANDERWICKEN became a Director of the Company on 6 September 2000. Mr. Vanderwicken is Chairman of the Audit Committee of Company. Mr. Vanderwicken is a private investor who retired in 2004 as president of Plumstead Group, Inc., a publishing and consulting firm. He is currently also a Director of Borealis Exploration Limited, Avto Metals plc, Cool Chips plc, Power Chips plc, Photon Power plc, Faraway plc, and Chairman of Roche Bay plc. Peter Vanderwicken beneficially owns directly or indirectly 10,979 shares of Chorus Motors plc.

Fidecs Management Limited became Corporate Secretary of the Company on 21 May 2001.

6. APPOINTMENT OF AUDITORS:

Unless otherwise specified therein, it is presently intended to vote the proxy to appoint Moore Stephens, Chartered Accountants, Gibraltar, as auditors of the Company, to hold office until the next annual meeting of shareholders, and to authorize the Directors to fix their remuneration.

7. INSURANCE:

The Company has liability insurance for its various offices and facilities worldwide. The Company indemnifies all of its Officers and Directors against any legal actions or threatened legal actions that are in any way related to their relationship to the Company. The indemnification includes paying all legal bills and all costs of any kind relating to any such claims.

8. INTEREST OF LARGE SHAREHOLDERS IN MATERIAL TRANSACTIONS WITH THE COMPANY:

Borealis Technical Limited collects a nominal annual retainer fee for managing the business of Chorus Motors plc, but pays all of Chorus Motors plc expenses. All funds raised by the sale of Chorus Motors plc shares go to Borealis Technical Limited, where they become an account payable to Chorus Motors plc.

9. GENERAL:

The Management knows of no matter to come before the Annual Meeting other than the matters referred to in the Notice of the Meeting. If any matters that are not now known to the Management should properly come before the meeting, the accompanying proxy instrument will be voted on such matters in accordance with the best judgment of the person or persons voting it.

The contents and sending of this information have been approved by the Directors of the Company.

Dated 10 June 2006

Chorus Motors plc



Rodney T. Cox, Ph.D.
CEO/Chairman of the Board

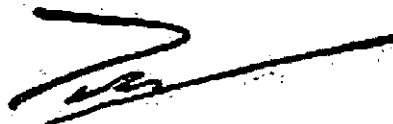

Isaiah W. Cox, A.B.
President/COO

Chorus Motors plc

Registered in Gibraltar, number 68312

Montagu Pavilion

8-10 Queensway

Gibraltar

212

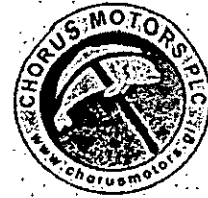

Certification:

These financial statements, and the notes thereto, are based on the best information currently available to the Company, and to the best of my knowledge present fairly, in all material respects, the financial position of the Issuer and the results of its operations and cash flow for the periods presented, in conformity with accounting principles generally accepted in Gibraltar and the United Kingdom, consistently applied.

Chorus Motors plc

Rodney T. Cox
CEO

204

Phone:	Gibraltar +350.59995	England +44.207.101.9592	US +1.503.621.3286	e-mail: exec@chorusmotors.gi
Fax:	+350.59059	+44.207.504.3593	+1.503.296.2163	www.chorusmotors.gi

2006



Chorus Motors plc

NOTICE OF ANNUAL MEETING OF MEMBERS

NOTICE IS HEREBY GIVEN, that the Annual General Meeting of Members of Chorus Motors Public Limited Company will be held on Tuesday, the 20th day of June 2006, at the hour of 17:30 (Gibraltar time), at the offices of Fidecs Management Limited, 8-10 Queensway, Montague Pavilion, Gibraltar, and on the Internet at www.chorusmotors.gi, for the purposes described in this Notice. Members are cordially invited to attend this meeting.

1. To elect 3 Directors, each for a 3-year term.
2. To appoint auditors for the year ending 31 March 2007.
3. To table the financial statements for the year ended 31 March 2006.
4. To approve and ratify all acts and resolutions of the Board of Directors since the last annual meeting of Members of the Company.
5. To transact any further business as may properly come before the meeting.

Dated this 30th day of May 2006.

By Order of the Board of
Chorus Motors plc

Rodney T. Cox, Ph.D.
CEO and Chairman of the Board

Isaiah W. Cox, A.B.
President and Director

Members who are unable to attend the meeting in person are requested to date, sign, and return the enclosed form of proxy in the envelope provided for that purpose, or to fax it to +44.207.504.3593, or in the States to +1.503.296.2163 or any Chorus Motors office. The proxy will be available for voting at the Chorus Motors website, www.chorusmotors.gi, from 6 June 2006. The proxy will also be accepted if sent in electronic form to proxy@chorusmotors.gi. Even if you plan on attending the meeting electronically we would appreciate your proxy before the meeting and you will still be allowed to vote in person at the meeting. There is always a possibility that the phone lines or the Internet will be down at the time of the meeting and sending in the proxy ensures your vote will be counted. Please note: the audited financial statements and information circular will be available at: www.chorusmotors.gi/investor/corpinfo.shtml.

RECEIVED
2006 AUG 22 A 9:56
OFFICE OF INTERNATIONAL
CORPORATE FINANCE

2006

Chorus Motors plc

PROXY

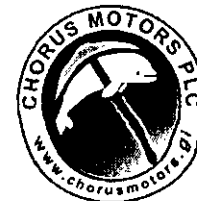

SOLICITED BY MANAGEMENT

I/We _____ being a member of the above Company with shares HEREBY APPOINT Rodney T. Cox, Isaiah W. Cox, Wayne S. Marshall, Peter Vanderwicken and Fidecs Management Limited, each with full power to act without the others and each with full power of substitution, or in lieu of the foregoing _____ to be my/our proxy to vote for me/us at the meeting of members to be held in Gibraltar, and on the Internet at www.chorusmotors.gi on the 20th day of June 2006, at the hour of 17:30 hours (Gibraltar Time), or at any adjournment thereof.

- (a) VOTED FOR () AGAINST () WITHHELD FROM VOTING () the election of **Isaiah W. Cox**, Director, for a three year term.
- (b) VOTED FOR () AGAINST () WITHHELD FROM VOTING () the election of **Nechama J. Cox**, Director, for a three year term.
- (c) VOTED FOR () AGAINST () WITHHELD FROM VOTING () the election of **Giulio Pontecorvo**, Director, for a three year term.
- (d) VOTED FOR () AGAINST () WITHHELD FROM VOTING () the appointment of **Moore Stephens, Chartered Accountants**, Gibraltar, for Auditors of the Company for the year ending 31 March 2007.
- (e) VOTED FOR () AGAINST () WITHHELD FROM VOTING () to approve and ratify all acts and resolutions of the Board of Directors since the last annual meeting of the members of the Company.

Signed this _____ day of _____ 2006

«HOLDER_1»
 «HOLDER_2»
 «HOLDER_3»
 «HOLDER_4»
 «ADDRESS_1»
 «ADDRESS_2»
 «ADDRESS_3»
 «CITY» «STATE» «ZIP_CODE»
 «COUNTRY»

Signature of Member (name to be written exactly as it appears to the left, or on your share certificate, or Signature of Member and Intermediary's Name in which the shares are held)

Number of shares owned: «SHARES»

For voting on-line, you will need: Username: «USERNAME»

Password: «PASSWORD»

Shareholders are requested to confirm or provide the following information:

Citizenship: «CITIZENSHIP»
 Occupation: «OCCUPATION»
 Phone #: «PHONE»
 Email: «EMAIL»

NOTE:

- (1) EACH MEMBER HAS THE RIGHT TO APPOINT A PERSON, WHO NEED NOT BE A MEMBER, TO ATTEND AND ACT FOR HIM AND ON HIS BEHALF AT THE MEETING OTHER THAN THE PERSONS SPECIFIED ABOVE. Such right may be exercised by inserting the name of the person to be appointed in the space provided after "in lieu of the foregoing," or by completing another proper form of Proxy. Each member can vote their proxy and attend the meeting and vote in person or vote electronically. The Record Date for the meeting is 4 MAY 2006.
- (2) If this form of Proxy is to be utilized, it must be dated and signed by the member, or by an Attorney duly authorized in writing, or, if the member is a Corporation, under its Corporate Seal or under the hand of an Officer or Attorney thereof duly authorized. This proxy is acceptable if sent by electronic form to proxy@chorusmotors.gi, and also can be voted at the Chorus Motors Web Site www.chorusmotors.gi from 6 June 2006. Faxed copies are acceptable if sent to +44.207.504.3593, or in the States to +1.503.296.2163, or any of the Chorus Motors corporate offices.
- (3) Unless otherwise specified, the shares represented by this Proxy instrument will be voted. If the choice is specified with respect to the matter to be dealt with at the meeting referred to above, such shares will be voted in accordance with the specifications made. IF NO CHOICE IS SPECIFIED, it is presently intended to vote such shares for the approval of all matters set out in the notice; including the election of ISALAH W. COX, NECHAMA J. COX and GIULIO PONTECORVO, each for a 3-year term, and the appointment of MOORE STEPHENS, chartered accountants, as auditors, and THIS PROXY CONFERS DISCRETIONARY AUTHORITY TO DO SO. This Proxy also confers authority for the above named to vote in his/their discretion with respect to amendments or variations to the matters identified in the Notice of Annual Meeting accompanying this Proxy instrument or matters which may properly come before the meeting.



Chorus Motors plc

GIBRALTAR COMPANY NUMBER 68312
INFORMATION CIRCULAR
Fiscal Year 2005

RECEIVED
2005 AUG 22 A 9:56
OFFICE OF INTERNATIONAL
CORPORATE FINANCE

1. SOLICITATION OF PROXIES:

This information circular is furnished in connection with the solicitation of proxies by the Management of Chorus Motors plc ("Company") for use at its Annual Meeting of Members to be held 28 June 2005 in Gibraltar and via the Internet at www.chorusmotors.gi, with the Record Date of the meeting being 29 April 2005, for the purposes set forth in the Notice of Meeting. It is expected that the solicitation will be by mail, e-mail, fax, Internet web site, telephone or in person by Officers and Directors of the Company. The cost of solicitation will be borne by the Company. The information contained herein is given as of 31 March 2005, unless otherwise indicated. All dollar figures set forth are expressed in United States Dollars. All accounting is done in accordance with Gibraltar Generally Accepted Accounting Principles (GAAP).

2. QUORUMS AND VOTING:

The authorised share capital of the Company is \$100,000, consisting solely of one class of common shares divided into 10,000,000 shares with par value of \$0.01 per share, of which 6,493,769 shares were outstanding at the close of business 31 March 2005.

Each holder of record of a common share as of the Record Date for the meeting is entitled to attend the meeting and to cast one vote for each share. Proxies are being accepted by hand delivery, mail, e-mail, fax, and the Company's Internet website at www.chorusmotors.gi. Any resolution to be voted upon at the meeting must be approved by a majority of the votes cast, unless the Company's Articles of Association stipulate a number or proportion of the votes cast in excess of a majority. The meeting will proceed as long as there is a quorum at the meeting place including the voted proxies.

3. REVOCATION OF PROXIES:

Each shareholder has the power to revoke a proxy at any time as long as it has not been exercised. In addition to revocation in any other manner permitted by law, a member giving a proxy pursuant to this solicitation who wishes to revoke the proxy instrument may do so in writing. This revocation must be executed by the member, or by his attorney authorised in writing, or, if the member is a Corporation, under its Corporate seal or by an officer or attorney thereof duly authorised, and received by mailed, or deposited, at any office of the Company, via e-mail to proxy@chorusmotors.gi, or by fax to +44.207.504.3593 at any time up to and including the last business day preceding the day of the meeting, or any adjournment thereof at which the proxy is to be used, or with the Chairman of such meeting on the day of the meeting, or adjournment thereof.

4. PRINCIPAL HOLDERS OF VOTING SHARES:

To the knowledge of the Directors and Officers of the Company there is no person who beneficially owns or exercises control or direction over shares carrying more than ten percent of the votes attached to shares of the Company as of 31 March 2005 except:

The Parmenides Group holds 5,895,540 shares or 90.79% of the outstanding shares. Borealis Technical Limited (which is a 98% owned subsidiary of Borealis Exploration Limited) owns 5,266,631 shares, which is 81.10% of the outstanding shares. The Parmenides Group holds these shares as fiduciary and disclaims ownership or control of these shares.

5. ELECTION OF DIRECTORS:

Present Directors

Rodney T. Cox, Ph.D.
Stuart Harbron, Ph.D.
Peter Vanderwicken, A.B.
Isaiah W. Cox, A.B.
Nechama J. Cox, Ph.D.
Giulio Pontecorvo, Ph.D.
Robert T. Bauer, M.S.
John Klys
Wayne S. Marshall, Ph.D.

Remaining Term

up for election
up for election
up for election
1 year
1 year
1 year
2 years
2 years
2 years

The proxy will be voted for the following proposed nominees (or for a substitute nominee in the event of contingencies not known at present) who will serve for a period of 3 years, or their successors if they are elected or appointed in accordance with the Articles of Association of the Company. Respective reported share totals are as at 29 April 2005.

RODNEY T. COX became Chief Executive Officer on 18 March 1999. Dr. Cox became a Director and Chairman of the Board of the Company on 21 December 1999. He is a member the Executive, Audit and Compensation Committees. He was a Partner in The Parmenides Group until February 2000. He is currently also a Director of Borealis Exploration Limited, Borealis Technical Limited, Avto Metals plc, Cool Chips plc, Photon Power plc, Power Chips plc, Roche Bay Holdings Limited, Roche Bay Holdings (Barbados) Limited, Roche Bay plc, Credits Holdings Limited, Borealis Roche Bay Limited, WheelTug plc, Cool Chips Military Sales plc, and Faraway plc. Dr. Cox is a Member of the Council of The Hart Cox Foundation Limited and The Jeremiah Toyam Cox Foundation Limited, among other foundations based in Gibraltar. Rodney T. Cox beneficially owns directly or indirectly 48,165 shares of Chorus Motors plc.

STUART HARBON became a Director of the Company on 23 July 2002. Dr Harbron is Chief Patent Officer for the Company. He is the owner of The Enzyme Technology Consultancy, a consulting business specializing in providing IP intelligence to the biotechnology industry. He is currently also a Director of Avto Metals plc, Borealis Exploration Limited, Cool Chips plc, and Power Chips plc. Dr. Harbron is a Member of the Council of The Edgar Research Foundation. Stuart Harbron beneficially owns directly or indirectly 780 shares of Chorus Motors plc.

PETER VANDERWICKEN became a Director of the Company on 6 September 2000. Mr. Vanderwicken is Chairman of the Audit Committee of Company, Mr. Vanderwicken is a private investor who retired in 2004 as president of Plumstead Group, Inc., a publishing and consulting firm. He is currently also a Director of Borealis Exploration Limited, Avto Metals plc, Cool Chips plc, Power Chips plc, Photon Power plc, Faraway plc, and Roche Bay plc. Peter Vanderwicken beneficially owns directly or indirectly 10,979 shares of Chorus Motors plc.

THE PRESENT POSITION AND OFFICE WITH THE COMPANY IF APPLICABLE, AND THE PRESENT PRINCIPAL OCCUPATION OR EMPLOYMENT OF THE INCUMBENT DIRECTORS AND OFFICERS ARE AS FOLLOWS. UNLESS OTHERWISE STATED, SUCH OCCUPATION OR EMPLOYMENT HAS CONTINUED FOR MORE THAN THE LAST FIVE YEARS.

ISAIAH W. COX became a Director of the Company on 21 December 1999. Mr. Cox is President, Chief Operating Officer, and a member of the Executive Committee and the Compensation Committee of the Company. He is currently also a Director of Borealis Exploration Limited, Borealis Technical Limited, Avto Metals plc, Cool Chips plc, Photon Power plc, Power Chips plc, Roche Bay Holdings Limited, Roche Bay Holdings (Barbados) Limited, Credits Holdings Limited, Borealis Roche Bay Limited, WheelTug plc, Cool Chips Military Sales plc, and Faraway plc. Mr. Cox is a Member of the Council of The Jeremiah Toyam Cox Foundation Limited and The Hart Cox Foundation Limited, among other foundations based in Gibraltar. Isaiah W. Cox beneficially owns directly or indirectly 32,810 shares of Chorus Motors plc.

NECHAMA J. COX became a Director of the Company on 1 August 2001. Dr. Cox is the European Regional Manager of the Company as well as for Borealis Technical Limited, Cool Chips plc and Power Chips plc. Since July 2002, she has directed the Chorus Motors plc research and product development effort. In 1999, she founded the Mishkan School as well as being a Founding Governor of the Noam Primary School. She is currently also a Director of Borealis Exploration Limited, Chorus Motors plc, Cool Chips plc, Photon Power plc and Power Chips plc She is a Member of the Council of a number of foundations based in Gibraltar. Nechama J. Cox beneficially owns directly or indirectly 5,775 shares of Chorus Motors plc.

GIULIO PONTECORVO became a Director of the Company on 28 August 2003. He is a Professor Emeritus at the Columbia University Graduate School of Business, and has served on numerous National Academy of Science committees. Professor Pontecorvo has advised the United Nations, the World Bank and other multilateral organizations on a variety of economic and environmental issues, and has published widely on many economic, financial and environmental topics. Dr. Pontecorvo is currently also a Director of Borealis Exploration Limited, Cool Chips plc, and Power Chips plc. Giulio Pontecorvo beneficially owns directly or indirectly 4,169 shares of Chorus Motors plc.

ROBERT T. BAUER became a Director of the Company on 17 May 2004. Mr. Bauer is an Advisory Software Engineer at IBM Corporation, and holds adjunct faculty positions at the Oregon Graduate Institute, Portland State University and Portland Community College. He is also a Director of Borealis Exploration Limited, Cool Chips plc, and Power Chips plc. Robert T. Bauer beneficially owns directly or indirectly 500 shares of Chorus Motors plc.

JOHN KLYS became a director 21 December 1999. Mr. Klys is a business consultant. John Klys beneficially owns directly or indirectly 10,000 shares of Chorus Motors plc.

WAYNE S. MARSHALL became a Director of the Company on 21 December 1999. He retired as a Professor of Business Administration from Long Island University, where he remains an Emeritus Professor. Dr. Marshall is Chairman of the Executive and Compensation Committees, and a member of the Audit Committee of the Company. He is currently also a Director of Borealis Exploration Limited, Borealis Technical Limited, Avto Metals plc, Cool Chips plc, Photon Power plc, Power Chips plc, Roche Bay Holdings Limited, Roche Bay Holdings (Barbados) Limited, Roche Bay plc, Credits Holdings

Limited, Borealis Roche Bay Limited, WheelTug plc, Cool Chips Military Sales plc, and Faraway plc. Dr. Marshall is a Member of the Council of The VSBM Foundation Limited, among other foundations based in Gibraltar. Wayne S. Marshall beneficially owns directly or indirectly 29,171 shares of Chorus Motors plc.

Fidex Management Limited became Corporate Secretary of the Company on 21 May 2001.

6. APPOINTMENT OF AUDITORS:

Unless otherwise specified therein, it is presently intended to vote the proxy to appoint Moore Stephens, Chartered Accountants, Gibraltar, as auditors of the Company, to hold office until the next annual meeting of shareholders, and to authorize the Directors to fix their remuneration.

7. INSURANCE:

The Company has liability insurance for its various offices and facilities worldwide. The Company indemnifies all of its Officers and Directors against any legal actions or threatened legal actions that are in any way related to their relationship to the Company. The indemnification includes paying all legal bills and all costs of any kind relating to any such claims.

8. INTEREST OF LARGE SHAREHOLDERS IN MATERIAL TRANSACTIONS WITH THE COMPANY:

Borealis Technical Limited collects a nominal annual retainer fee for managing the business of Chorus Motors plc, but pays all of Chorus Motors plc expenses. All funds raised by the sale of Chorus Motors plc shares go to Borealis Technical Limited, where they become an account payable to Chorus Motors plc.

9. GENERAL:

The Management knows of no matter to come before the Annual Meeting other than the matters referred to in the Notice of the Meeting. If any matters that are not now known to the Management should properly come before the meeting, the accompanying proxy instrument will be voted on such matters in accordance with the best judgment of the person or persons voting it.

The contents and sending of this information have been approved by the Directors of the Company.

Dated 30 May 2005

Chorus Motors plc



Rodney T. Cox, Ph.D.
CEO/Chairman of the Board



Isaiah W. Cox, A.B.
President/COO

2005



Chorus Motors plc

NOTICE OF ANNUAL MEETING OF MEMBERS

NOTICE IS HEREBY GIVEN, that the annual meeting of Members of Chorus Motors plc will be held on Tuesday, the 28th day of June 2005, at the hour of 17:30 (Gibraltar time), at the Offices of Fidecs Management Limited, 8-10 Queensway, Montague Pavilion, Gibraltar, and on the Internet at <http://www.chorusmotors.gi/>, for the purposes described in this Notice.

1. To elect 3 Directors, each for a 3-year term.
2. To appoint auditors for the year ending 31 March 2006.
3. To table the financial statements for the year ended 31 March 2005.
4. To approve and ratify all acts and resolutions of the Board of Directors since the last annual meeting of Members of the Company.
5. To transact any further business as may properly come before the meeting.

Dated this 16th day of May 2005.

By Order of the Board of
Chorus Motors plc

Rodney T. Cox, Ph.D.
CEO and Chairman of the Board

Isaiah W. Cox, A.B.
President, COO and Director

Members who are unable to attend the meeting in person are requested to date, sign, and return the enclosed form of proxy in the envelope provided for that purpose, or to fax it to +44.207.504.3593 or any Chorus Motors office. The company plans to have this proxy available for voting at the Chorus Motors website, www.chorusmotors.gi, from 6 June 2005. The proxy will also be accepted if sent in electronic form to proxy@chorusmotors.gi. Even if you plan on attending the meeting electronically we would appreciate your proxy before the meeting and you will still be allowed to vote in person at the meeting. There is always a possibility that the phone lines or the Internet will be down at the time of the meeting and sending in the proxy ensures your vote will be counted. PLEASE NOTE: THE AUDITED FINANCIAL STATEMENTS AND INFORMATION CIRCULAR ARE SCHEDULED TO BE AVAILABLE FROM 6 June 2005 AT <http://www.chorusmotors.gi/investor/corpinfo.shtml>.

2005
Chorus Motors plc
PROXY

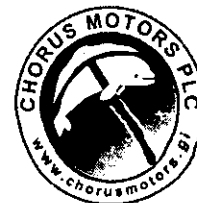

SOLICITED BY MANAGEMENT

I/We _____ being a member of the above Company with shares HEREBY APPOINT Rodney T. Cox, Isaiah W. Cox, Wayne S. Marshall, Peter Vanderwicken and Fidecs Management Limited, each with full power to act without the others and each with full power of substitution, or in lieu of the foregoing _____ to be my/our proxy to vote for me/us at the meeting of members to be held in Gibraltar, and on the Internet at www.chorusmotors.gi 28 June 2005, at the hour of 17:30 hours (Gibraltar Time), or at any adjournment thereof.

- (a) VOTED FOR () AGAINST () WITHHELD FROM VOTING () the election of **Rodney T. Cox**, Director, for a three year term.
- (b) VOTED FOR () AGAINST () WITHHELD FROM VOTING () the election of **Stuart Harbron**, Director, for a three year term.
- (c) VOTED FOR () AGAINST () WITHHELD FROM VOTING () the election of **Peter Vanderwicken**, Director, for a three year term.
- (d) VOTED FOR () AGAINST () WITHHELD FROM VOTING () the appointment of **Moore Stephens, Chartered Accountants**, Gibraltar, for Auditors of the Company for the year ending 31 March 2006.
- (f) VOTED FOR () AGAINST () WITHHELD FROM VOTING () to approve and ratify all acts and resolutions of the Board of Directors since the last annual meeting of the members of the Company.

Signed this _____ day of _____ 2005

«holder_1»
«holder_2»
«holder_3»
«holder_4»
«address_1»
«address_2»
«address_3»
«city» «state» «zip_code»
«country»

Signature of Member (name to be written exactly as it appears to the left, or on your share certificate, or Signature of Member and Intermediary's Name in which the shares are held)

Number of shares owned: «shares»

For voting on-line, you will need both of the following: Username: «username» Password: «password»

Shareholders are requested to confirm or provide the following information:

Citizenship: «citizenshi» _____
Occupation: «occupation» _____
Phone #: «phone» _____
Email: «email» _____

NOTE:

- (1) EACH MEMBER HAS THE RIGHT TO APPOINT A PERSON, WHO NEED NOT BE A MEMBER, TO ATTEND AND ACT FOR HIM AND ON HIS BEHALF AT THE MEETING OTHER THAN THE PERSONS SPECIFIED ABOVE. Such right may be exercised by inserting the name of the person to be appointed in the space provided after "in lieu of the foregoing," or by completing another proper form of Proxy. Each member can vote their proxy and attend the meeting and vote in person or vote electronically. The Record Date for the meeting is 29 April 2005.
- (2) If this form of Proxy is to be utilized, it must be dated and signed by the member, or by an Attorney duly authorized in writing, or, if the member is a Corporation, under its Corporate Seal or under the hand of an Officer or Attorney thereof duly authorized. This proxy is acceptable if sent by electronic form to proxy@chorusmotors.gi, and also can be voted at the Chorus Motors Web Site www.chorusmotors.gi from 6 June 2005. Faxed copies are also acceptable if sent to +44.207.504.3593, or any of the Chorus Motors corporate offices.
- (3) Unless otherwise specified, the shares represented by this Proxy instrument will be voted. If the choice is specified with respect to the matter to be dealt with at the meeting referred to above, such shares will be voted in accordance with the specifications made. IF NO CHOICE IS SPECIFIED, it is presently intended to vote such shares for the approval of all matters set out in the notice; including the election of Rodney T. Cox, Stuart Harbron, and Peter Vanderwicken, each for a 3-year term, and the appointment of MOORE STEPHENS, chartered accountants, as auditors, and THIS PROXY CONFERS DISCRETIONARY AUTHORITY TO DO SO. This Proxy also confers authority for the above named to vote in his/their discretion with respect to amendments or variations to the matters identified in the Notice of Annual Meeting accompanying this Proxy instrument or matters which may properly come before the meeting.

RECEIVED
2006 AUG 22 A 9:57
OFFICE OF INTERNATIONAL
CORPORATE FINANCE

CHORUS MOTORS PUBLIC LIMITED COMPANY

Unaudited Financial Statements
for the three months ending 30 June 2006
the first fiscal quarter of Fiscal Year 2007

CHORUS MOTORS PUBLIC LIMITED COMPANY

Registered No (Gibraltar) 68312

PROFIT AND LOSS ACCOUNT

For the three months ended 30 June 2006

	30 June 2006 \$	30 June 2005 \$
Revenue	<u>-</u>	<u>45,000</u>
Expenditure		
Administration fees	<u>16,200</u>	<u>61,200</u>
Retained losses for the period	(16,200)	(16,200)
Retained earnings brought forward	<u>562,848</u>	<u>(388,800)</u>
Retained earnings carried forward	\$ 546,648	\$ (405,000)

CHORUS MOTORS PUBLIC LIMITED COMPANY

Registered No (Gibraltar) 68312

BALANCE SHEET As at 30 June 2006

	30 June 2006	30 June 2005
	\$	\$
Investments	68,411	69,333
Current Assets		
Debtors	12,526,331	11,255,997
Creditors - amounts falling due within one year	69,333	69,333
Net current assets	<u>12,456,998</u>	<u>11,186,664</u>
Total Net Assets	<u>\$12,525,409</u>	<u>\$11,255,997</u>
Capital and Reserves		
Called up Share Capital	65,728	65,514
Share Premium Account	11,913,033	11,595,483
Profit and Loss Account	546,648	(405,000)
Total Shareholders' Funds	<u>\$12,525,409</u>	<u>\$11,255,997</u>

[See Exhibit 3]

RECEIVED
2006 AUG 22 A 9:57
OFFICE OF INTERNATIONAL
CORPORATE FINANCE

**CHORUS MOTORS PUBLIC
LIMITED COMPANY**
Consolidated Financial Statement

Unaudited Financial Statements
for the nine months ending 31 December 2005
the third fiscal quarter of Fiscal Year 2006

prepared 19 January 2006

CHORUS MOTORS PUBLIC LIMITED COMPANY

Registered No (Gibraltar) 68312

CONSOLIDATED PROFIT AND LOSS ACCOUNT

For the nine months ended 31 December 2005

	31 December 2005	31 December 2004
	\$	\$
Revenue		
Income from consulting fees	104,270	
Income from sale of WheelTug plc shares	960,804	
	<u>1,065,074</u>	<u> </u>
Expenditure		
Administration fees	48,600	48,600
	<u> </u>	<u> </u>
Retained losses/gains for the period	1,016,474	(48,600)
Retained losses brought forward	<u>(388,800)</u>	<u>(324,000)</u>
Retained losses/gains carried forward	\$ 627,674	\$ (372,600)

CHORUS MOTORS PUBLIC LIMITED COMPANY

Registered No (Gibraltar) 68312

CONSOLIDATED BALANCE SHEET

As at 31 December 2005

	31 December 2005	31 December 2004
	\$	\$
Current Assets		
Debtors	12,607,301	10,502,639
	<u> </u>	<u> </u>
Net current assets	12,607,301	10,502,639
	<u> </u>	<u> </u>
Total Net Assets	\$12,607,301	\$10,502,639
	<u> </u>	<u> </u>
Capital and Reserves		
Called up Share Capital	65,728	64,947
Share Premium Account	11,913,033	10,810,292
Profit and Loss Account	627,674	(372,600)
Minority Interest	866	--
	<u> </u>	<u> </u>
Total Shareholders' Funds	\$12,607,301	\$10,502,639
	<u> </u>	<u> </u>
Number of shares in issue	6,571,752	6,494,769

Chorus Motors plc

Registered in Gibraltar, number 68312
Montagu Pavilion
8-10 Queensway
Gibraltar



212

Certification:

These financial statements, and the notes thereto, are based on the best information currently available to the Company, and to the best of my knowledge present fairly, in all material respects, the financial position of the Issuer and the results of its operations and cash flow for the periods presented, in conformity with accounting principles generally accepted in Gibraltar and the United Kingdom, consistently applied.

Chorus Motors plc

Rodney T. Cox
CEO

24

	Gibraltar	England	US	
Phone:	+350.59995	+44.207.101.9592	+1.503.621.3286	e-mail:excc@chorusmotors.gi
Fax:	+350.59059	+44.207.504.3593	+1.503.296.2163	www.chorusmotors.gi

**CHORUS MOTORS PUBLIC
LIMITED COMPANY**
Consolidated Financial Statement

**Unaudited Financial Statements
for the six months ending 30 September 2005
the second fiscal quarter of Fiscal Year 2006**

CHORUS MOTORS PUBLIC LIMITED COMPANY

Registered No (Gibraltar) 68312

PROFIT AND LOSS ACCOUNT

For the six months ended 30 September 2005

	30 September 2005	30 September 2004
	\$	\$
Revenue		
Income from consulting fees	45,000	
Income from sale of WheelTug plc shares	758,097	--
	<u>803,097</u>	<u> </u>
Expenditure		
Administration fees	77,400	16,200
	<u> </u>	<u> </u>
Retained losses/gains for the period	725,697	(16,200)
Retained losses brought forward	<u>(388,800)</u>	<u>(324,000)</u>
Retained losses/gains carried forward	\$ 336,897	\$ (340,200)

CHORUS MOTORS PUBLIC LIMITED COMPANY

Registered No (Gibraltar) 68312

BALANCE SHEET

As at 30 September 2005

	30 September 2005	30 September 2004
	\$	\$
Current Assets		
Debtors	12,316,321	9,600,417
	<hr/>	<hr/>
Net current assets	12,316,321	9,600,417
	<hr/>	<hr/>
Total Net Assets	\$12,316,321	\$ 9,600,417
	<hr/> <hr/>	<hr/> <hr/>
Capital and Reserves		
Called up Share Capital	65,728	64,111
Share Premium Account	11,913,033	9,876,506
Profit and Loss Account	336,897	(340,200)
Minority Interest	663	--
	<hr/>	<hr/>
Total Shareholders' Funds	\$12,316,321	\$ 9,600,417
	<hr/> <hr/>	<hr/> <hr/>
Total number of shares in issue	6,571,752	6,493,769
	<hr/>	<hr/>

RECEIVED
2006 AUG 22 A 9:57
OFFICE OF INTERNATIONAL
CORPORATE FINANCE

CHORUS MOTORS PUBLIC LIMITED COMPANY

**Unaudited Financial Statements
for the three months ending 30 June 2005
the first fiscal quarter of Fiscal Year 2006**

CHORUS MOTORS PUBLIC LIMITED COMPANY

Registered No (Gibraltar) 68312

PROFIT AND LOSS ACCOUNT

For the three months ended 30 June 2005

	30 June 2005	30 June 2004
	\$	\$
Revenue	<u>45,000</u>	<u>--</u>
Expenditure		
Administration fees	<u>61,200</u>	<u>16,200</u>
Retained losses for the period	(16,200)	(16,200)
Retained losses brought forward	<u>(388,800)</u>	<u>(324,000)</u>
Retained losses carried forward	\$ (405,000)	\$ (340,200)

CHORUS MOTORS PUBLIC LIMITED COMPANY

Registered No (Gibraltar) 68312

BALANCE SHEET

As at 30 June 2005

	30 June 2005	30 June 2004
	\$	\$
Investments	69,333	--
Current Assets		
Debtors	11,255,997	9,600,417
Creditors - amounts falling due within one year	<u>69,333</u>	<u>--</u>
Net current assets	<u>11,186,664</u>	<u>9,600,417</u>
Total Net Assets	<u>\$11,255,997</u>	<u>\$ 9,600,417</u>
Capital and Reserves		
Called up Share Capital	65,514	64,111
Share Premium Account	11,595,483	9,876,506
Profit and Loss Account	<u>(405,000)</u>	<u>(340,200)</u>
Total Shareholders' Funds	<u>\$11,255,997</u>	<u>\$ 9,536,306</u>

[See Exhibit 3]

Information, Documents and Materials Distributed or Required to be Distributed to the Company's Shareholders since March 31, 2005

Information, Document or Material	Time Period	By Whom	Manner
Information Circular in connection with the Solicitation of Proxies for use at the 2006 Annual Meeting	prior to the date of the annual meeting	the Company's Memorandum and Articles of Association	by mail to shareholders
Notice of 2006 Annual Meeting of Members	not less than 21 days prior to the date of the annual meeting	the Company's Memorandum and Articles of Association	by mail to shareholders
2006 Proxy Statement	prior to or on the date of the annual meeting	the Company's Memorandum and Articles of Association	by mail to shareholders
Information Circular in connection with the Solicitation of Proxies for use at the 2005 Annual Meeting	prior to the date of the annual meeting	the Company's Memorandum and Articles of Association	by mail to shareholders
Notice of 2005 Annual Meeting of Members	not less than 21 days prior to the date of the annual meeting	the Company's Memorandum and Articles of Association	by mail to shareholders
2005 Proxy Statement	prior to or on the date of the annual meeting	the Company's Memorandum and Articles of Association	by mail to shareholders

Information, Documents and Materials Made or Required to be Made Public under Gibraltar Law since March 31, 2005

Information, Document or Material	Time Period	By Whom	Manner
Audited Financial Statements for the fiscal year ending 31 March 2006	within 90 days of the end of the fiscal year	the Registry	Filing with the Registry, which, in turn, makes the audited financial statements available for public inspection
Audited Financial Statements for the fiscal year ending 31 March 2005	within 90 days of the end of the fiscal year	the Registry	Filing with the Registry, which, in turn, makes the audited financial statements available for public inspection

Information, Documents and Materials Filed or Required to be Filed with the Pink Sheets since March 31, 2005

Information, Document or Material

Time Period

By Whom

Manner

Unaudited Financial Statements for the three months ending 30 June 2006

as soon as practicable after the end of the relevant period

the Pink Sheets

the Company submits the form to the Pink Sheets

Audited Financial Statements for the fiscal year ending 31 March 2006

as soon as practicable after the end of the relevant period

the Pink Sheets

the Company submits the form to the Pink Sheets

Unaudited Financial Statements for the nine months ending 31 December 2005

as soon as practicable after the end of the relevant period

the Pink Sheets

the Company submits the form to the Pink Sheets

Unaudited Financial Statements for the six months ending 30 September 2005

as soon as practicable after the end of the relevant period

the Pink Sheets

the Company submits the form to the Pink Sheets

Unaudited Financial Statements for the three months ending 30 June 2005

as soon as practicable after the end of the relevant period

the Pink Sheets

the Company submits the form to the Pink Sheets

Audited Financial Statements for the fiscal year ending 31 March 2005

as soon as practicable after the end of the relevant period

the Pink Sheets

the Company submits the form to the Pink Sheets

Press Releases issued by the Company since March 31, 2005

Title

Date Issued

Manner of Issuance

Borealis Announces Changes to Board of Directors (Refers to BOREF, COLCF, CHOMF, PWCHF)

10 March 2006

the Company released the press release to Market Wire for global distribution

Chorus Motors Partners with Magnetek for Underground Mining Devices

19 December 2005

the Company released the press release to Market Wire for global distribution

Chorus Motors Reports Progress in WheelTug™ Development

12 September 2005

the Company released the press release to Market Wire for global distribution

Boeing Demonstrates New Technology for Moving Airplanes on the Ground

1 August 2005

the Company released the press release to Market Wire for global distribution

A "Real" Virtual Company - What a Difference

5 April 2005

the Company released the press release to Market Wire for global distribution



Chorus Motors Cool Chips Power Chips Roche Bay Faraway Photon Power

- WheelTug

BOREF, COLCF, CHOMF & PWCHF Press Release Dated 13 Mar 2006

RECEIVED
2006 AUG 22 A 9:5
OFFICE OF INTERNATIONAL
CORPORATE FINANCING

-
- ABOUT US
-
- TECHNOLOGY
-
- INVESTORS
-
- NEWS
-
- HOME
- CONTACT
- SEARCH

BOREALIS ANNOUNCES CHANGES TO BOARD OF DIRECTORS

Refers to BOREF, COLCF, CHOMF, PWCHF

Gibraltar, 10 March 2006 – Borealis Exploration Limited (BOREF) announces that Nechama Katan and Mel Simon have joined the board of directors.

Nechama Katan completed a BA in Mathematics from Barnard College, an MS in Mathematics from NYU and a MA in statistics from Columbia University. She worked for Intel Corporation for more than seven years, in performance analysis, cpu design, process development and high volume manufacturing process control. Since May 2005 she has been Program Manager for Avto Metals, Power Chips and Cool Chips, posts in which she continues.

Mel Simon worked for IBM for 34 years. Amongst his many roles he was UK Internet Marketing Manager, UK Head of Network Consultancy, European Open Systems Manager and Global Strategy Manager for Capital Markets. Subsequently he was e-Commerce Director for Moneybox plc. Mr. Simon has been working with the Borealis Family of Companies in various consultative roles since 2001.

"We have made some substantial changes to the membership of our Board, and it serves to strengthen Borealis' expertise and capabilities as we drive toward products and profits," said Dr. Rodney T. Cox, Borealis' Chairman. "The last few months have had a great deal of change as our subsidiaries have continued to devolve and seek to independently create value for their shareholders. We look forward to great things from these companies."

Borealis Exploration Limited also announces with regret that Robert T. Bauer has resigned from the boards of Borealis Exploration Limited, Chorus Motors plc, Cool Chips plc and Power Chips plc. Benjamin J. Cox has also resigned from the board of Borealis Exploration Limited. The Board of Directors thanks them both for their contributions to the Borealis Family of Companies and wishes them every success in his future projects.

Joseph J. Cox has joined the board of directors of WheelTug plc, a majority-owned subsidiary. He is now the President and COO of WheelTug plc.

In another change, Dr. Robert L. Carman Jr has stepped down as the WheelTug Program Manager at Chorus Motors plc. Dr Carman stated "I wish to document my pleasure in working with you and your organization. The WheelTug(tm) demonstration project was certainly a challenging opportunity where the entire WheelTug team certainly got an opportunity to showcase all our skills. It is always great when programs work successfully. Thanks for the opportunity to work with the WheelTug team. Let me know of anything else you need from me to aid and assist as the program moves forward to the next stages of development."

The Borealis Family of Companies also includes:

Borealis Exploration Limited (BOREF) is a research and development company founded in 1968 and based in Gibraltar in the European Union. Borealis has 5,000,000 shares outstanding. Borealis' business is reinventing the core technologies used by basic industries, including electric motors, steelmaking, electrical power generation, and cooling and

refrigeration. For more information and forward looking statements please visit its web site at www.borealis.gi.

Chorus Motors plc (CHOMF) has developed the proprietary Chorus and Meshcon(tm) electric motor technologies which offer substantial cost and performance improvements over comparable motor and drive systems. The Chorus Motor system produces high torque at startup speeds and is ideal for traction applications such as automobiles, trucks, locomotives, and ships. Its advantages enable several potentially innovative applications in aerospace. As of 31 March 2005, Chorus Motors plc had 6,493,769 shares outstanding.

Cool Chips plc (COLCF) and Power Chips plc (PWCHF) are developing proprietary technologies for cooling and power generation applications. Cool Chips and Power Chips are projected to produce cooling and electric power, respectively, more efficiently and less expensively than existing or emerging technologies. As of 31 March 2005, Cool Chips plc had 8,245,347 shares outstanding, and Power Chips plc had 8,035,118 shares outstanding.

Chorus is a registered trademark of Chorus Motors plc.

For further information please contact:

Borealis Exploration Limited
Chris Bourne
Head of Public Relations
email: pr@borealis.gi
Tel: +44 020 8571 5216
Fax: +44 020 8455 8701
www.borealis.gi

Please note our forward looking statement which can be found at www.borealis.gi , www.coolchips.gi , www.powerchips.gi , www.chorusmotors.gi

Copyright © 1995 - 2006 Borealis Exploration Limited. All rights reserved.
Forward-Looking Statement may be found at <http://www.borealis.gi/fwdlook.shtml>

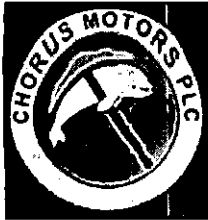

CHORUS MOTOR

Chorus Motors - Magnetek Press Release Dated December 19, 2005

ABOUT US

TECHNOLOGY

INVESTORS

NEWS

HOME

CONTACT

SEARCH

CHORUS MOTORS PARTNERS WITH MAGNETEK FOR UNDERGROUND MINING DRIVES

http://www.marketwire.com/mw/release_html_b1?release_id=104443

Refers To:
CHOMF Chorus Motors plc
MAG: Magnetek Inc.

CHORUS MOTORS PARTNERS WITH MAGNETEK FOR UNDERGROUND MINING DRIVES

Gibraltar, December 19, 2005

Chorus Motors plc (US OTC: CHOMF) has signed an agreement with Magnetek Inc. (NYSE: MAG) to develop traction drive technology for the underground mining industry. The companies plan to offer complete motor and drive systems for customers who demand the highest performance and reliability in the smallest available package.

Chorus drive and control systems offer unequalled power density in a compact AC unit, together with the ability to switch between high and low torque applications without loss of efficiency, allowing the same system to be used as a generator as well as a traction motor.

Magnetek is a market leader for drives and controls to the underground mining market. It has over 30 years experience in designing and manufacturing industrial power controllers with a range of solutions for the most severe duty equipment as well as custom designs.

"Magnetek is an excellent partner for us"; said Isaiah Cox, Chorus's President. "The underground mining market has very rigorous requirements in which reliability and performance are at a premium, and Magnetek will ensure that the products we make will meet and exceed the industry's expectations."

?The Chorus technology allows Magnetek to provide an AC motor and drive package with torque performance equal or greater than the existing Series DC controls? according to Ed Butte, Magnetek VP Product Management. ?It also provides a level of redundancy that will

allow greater up-time and throughput for our mining customers.?

The agreement provides for the development of Chorus® motors for haulage equipment, shuttle cars, and regenerative traction drives, with further products envisaged over time. Marketing, integration, sales and ongoing service and repair contracts will be handled by Magnetek.

About Chorus Motors:

Chorus Motors plc (US OTC: CHOMF) is a majority-owned subsidiary of Borealis Exploration Limited (US OTC: BOREF). Chorus has developed the proprietary Chorus® Star and Chorus® Meshcon™ electric motor technologies, which offer substantial performance improvements over comparable motor and drive systems. The Chorus systems produce high torque at start-up speeds and are ideal for traction applications such as automobiles, trucks, locomotives, and ships. The system is also suitable for aircraft ground maneuvers and has been successfully tested in the form of an onboard aircraft nosewheel motor.

For more information, see www.chorusmotors.gi

About Magnetek:

Magnetek, Inc. manufactures digital power products for industrial automation, communications, information technology, consumer products, alternative energy, power generation, transportation, and other applications requiring highly reliable, precise, energy-efficient power. The Company operates manufacturing and research facilities in North America, Europe and China employing over 1,700 people, and reported total revenue of \$242 million for its 2005 fiscal year, which ended on July 3, 2004. For additional information, visit Magnetek's web site at www.magnetek.com.

For further information contact:

Chris Bourne
Head of Public Relations
Chorus Motors plc
+44 (0)20 8571 5216
pr@chorusmotors.gi

or

Robert Murray
Magnetek, Inc.
818/727-2216 (ext. 111)
bmurray@magnetek.com

Copyright © 1995 - 2006 Chorus Motors plc. All rights reserved.
Forward Looking Statement may be found at <http://www.chorusmotors.gi/fwdlook.shtml>.



Chorus Motors Press Release Dated September 12, 2005

-
- ABOUT US
-
- TECHNOLOGY
-
- INVESTORS
-
- NEWS
-
- HOME
- CONTACT
- SEARCH

Chorus Motors Reports Progress in WheelTug(TM) Development

http://www.marketwire.com/mw/release_html_b1?release_id=094984

Refers To:
BOREF Borealis Exploration Limited
CHOMF Chorus Motors plc
WheelTug plc

CHORUS MOTORS REPORTS PROGRESS IN WHEELTUG DEVELOPMENT

Gibraltar, 12 September 2005

Chorus Motors plc(US OTC: CHOMF) and WheelTug plc confirmed today that they have designed an initial version of a WheelTug™ drive that can fit within the existing nose wheel hub of a 767-class aircraft, with the goal of largely eliminating the use of tow tugs and jet engines in moving aircraft on the ground.

As announced by The Boeing Company, in a Press Release on 1 August 2005

http://www.boeing.com/news/releases/2005/q3/nr_050801a.html,

"Successful tests in June of an onboard electric motor attached to the nose wheel of a Boeing 767 have shown that it may be a viable way of powering airplanes to move in and around gates, largely eliminating the use of airport tow tugs and jet engines now serving this purpose, as well as reducing emissions."

The first significant step is to go from the proof-of-concept demonstrator as proven in the June tests, to a motor design which could approach the challenging goals of fitting entirely within existing nose gear, as well as being weight-neutral.

"The design we have gets us most of the distance of where we need to go in terms of the drive motor design itself," says Bob Carman, WheelTug's Program Manager. "There will remain a very considerable effort ahead of us with regards to refinements after performance testing, systems testing, integration, and certification, but getting the drive package the right shape and size and near the correct weight is a very

RECEIVED
AUG 22 AM 5:51
OFFICE OF INTERNATIONAL
CORPORATE FINANCE

significant advance in bringing WheelTug to the product stage."

An economic analysis by WheelTug plc estimates that a typical WheelTug System would have a net present value to airlines of over \$6 million per airplane, though valuations would vary by aircraft type, utilization, and other factors. Savings are created by reduced turnaround times and lower fuel consumption, greenhouse gas emissions, ground equipment costs, damage to turbines and aircraft from foreign object debris and mishandling, maintenance costs, and noise. The analysis, which is based solely on publicly available information, can be found at <http://www.wheeltug.gi/value.php>.

While onboard electric drive motors for aircraft have been envisaged for decades, they have not been technically feasible due to the exceptionally high power density required. The Chorus Motor, which recently became available, delivers this exceptionally high power density. WheelTug plc, under its license from Chorus Motors, owns exclusive rights to this drive technology and control systems for aerospace applications.

The development of the WheelTug system thus far has been funded entirely by Chorus Motors, but in order to ensure rapid development, Chorus is now considering the sale of a substantial equity interest in WheelTug plc. Funds would be applied to final development and FAA certification process for the WheelTug system. No decision on such an equity placement has yet been made.

Chorus Motors plc (US OTC: CHOMF), a developer of proprietary electric motor technologies, is a subsidiary of Borealis Exploration Limited (US OTC: BOREF). The Chorus systems produce high torque at start-up speeds and can be used in applications in aircraft, automobiles, trucks, locomotives, and ships. A wholly-owned subsidiary of Chorus Motors plc, WheelTug plc, has been assigned rights for aerospace applications of the Chorus family of motor technologies. For more information, see www.chorusmotors.gi, www.wheeltug.gi, www.borealis.gi.

Contact
Isaiah Cox
President
WheelTug plc
Isaiah@wheeltug.gi
+1 410-419-0082
+44 (0) 207.993.4293

Forward Looking Statement at <http://www.chorusmotors.gi/fwdlook.shtml>

Copyright © 1995 - 2006 Chorus Motors plc. All rights reserved.
Forward Looking Statement may be found at <http://www.chorusmotors.gi/fwdlook.shtml>.



RECEIVED

2005 AUG 22 A 9:57

INTERNATIONAL
CORPORATE FINANCE

Boeing Demonstrates New Technology for Moving Airplanes on the Ground

SEATTLE, Aug. 01, 2005 -- The Boeing Company [NYSE: BA] and Chorus Motors have demonstrated an exploratory technology that could lead to a more efficient way of moving airplanes when they are on the ground at airports.

Successful tests in June of an onboard electric motor attached to the nose wheel of a Boeing 767 have shown that it may be a viable way of powering airplanes to move in and around gates, largely eliminating the use of airport tow tugs and jet engines now serving this purpose, as well as reducing emissions:

"We are striving to help our aerospace customers operate more efficiently, cleanly and quietly at airports," said Jim Renton, a director of Technology Integration in Boeing Phantom Works, the company's advanced research and development unit. "Our testing has shown that onboard electric motors can be very useful in achieving that goal if packaging, weight and flight-related technical issues identified during these tests can be resolved."

"We believe onboard electric motors have a great many advantages," added Bob Carman, Chorus Motors' WheelTug™ program manager. "They could reduce the need for ground tugs and their associated costs, allow faster flight turnarounds and increased fuel efficiency per trip, and reduce airplane noise and emissions at airports, to name just a few advantages."

Phantom Works researchers, together with those from Chorus Motors, a developer of innovative electric motor technologies, have worked together this year to design, build and operate a prototype onboard electric drive system that may enable pilots of large airplanes to be in complete control of their airplanes from gate to gate.

In June, the Phantom Works/Chorus Motors team, in cooperation with Air Canada, installed an electric motor drive on an Air Canada 767 and conducted a series of successful tests. Air Canada pilots performed ground maneuvers on slopes and terrains typical of those at airports around the world, including driving in reverse from a gate and taxiing forward to a runway. Tests also were performed at ramp temperatures exceeding 120 degrees Fahrenheit and at loads of up to 94 percent of the maximum takeoff weight for the airplane.

"Powered nose wheels have very positive benefits and I am quite impressed with the potential of the electric motor technology," said Capt. Hugh Campbell, director of Pilot Qualifications at Air Canada, who participated in the testing with Air Canada's chief 767 pilot, Capt. Richard Burke.

Next steps involve working to successfully resolve the technical issues that surfaced during the tests in order to define a path for commercial system installation.

Boeing Phantom Works is the advanced R&D unit of The Boeing Company. As an element of Boeing Technology, it provides advanced system solutions and innovative, breakthrough technologies that reduce cycle time and cost while improving the quality and performance of aerospace products and services. In addition to its own development work, Phantom Works collaborates with universities, companies, and organizations around the globe to ensure it is finding the best technology solutions the world has to offer.

Chorus Motors plc (US OTC: CHOMF), a developer of proprietary electric motor technologies, is a subsidiary of Borealis Exploration Limited (US OTC: BOREF). The Chorus systems produce high torque at start-up speeds and can be used in applications in aircraft, automobiles, trucks, locomotives, and ships. A wholly-owned subsidiary of Chorus Motors plc, WheelTug plc, has been assigned rights for aerospace applications of the Chorus family of motor technologies. For more information, see www.chorusmotors.gi.

###

CONTACT INFO:

Tom Koehler

Phantom Works Communications

Boeing

206-766-2923

thomas.j.koehler@boeing.com

Bob Carman

Program Manager for Aerospace Applications

Chorus Motors

805-908-1762

rcarman@chorusmotors.gi

[Site Terms](#) | [Privacy Policy](#) | [Contact Us](#) | [FAQ](#)

Copyright © 1995 - 2006 Boeing. All Rights Reserved.

RECEIVED

2005 AUG 22 A 9:57

OFFICE OF INTERNATIONAL
CORPORATE FINANCE

A "Real" Virtual Company — What a Difference !

Dr. Robert Carman
Carman & Associates

WESTEC 2005

April 5, 2005



WESTEC

Classical Companies - Internal

- Compartmentation of virtually every aspect of business with specialist for each activity
- Large Number of Team Members for all Process and Product Teams
- People on programs are best available, not best in the world
- Multiple levels of "detached" management, frequently viewed as main source of "problems" or holding on until retirement
- Visibility into related activities at all levels leaves much to be desired
- Long time lag between information arrival and information acted upon or decisions made, which is paralyzing the business.
- Rules and Policies created as process fixes, and policing is compartmented with visibility only to specialized middle managers
- Intellectual property frequently decoupled from internal investments implying large variations in measurable benefits

Bob Carman 4/6/05



Classical Companies - Interfaces

- Supply Chain has little connection to ultimate customer satisfaction and is not a true partnership
- Isolated Board of Directors from where the work is done implying information time lag and "filtering"
- Detached & Dissatisfied Stockholders who can create revolts and Executive upheavals
- Strategic direction changes take a long time to make and to get total buy-in.
- Start Up Companies frequently are the source of reinvention of business and large shifts in basis of competition creating more turmoil and leading to increased executive staff size requirements



Bob Carman 4/6/05

Extending Global Engineering Competitiveness Across the Supply Chain

Effective implementation of this next generation will require that people, processes and technologies be brought into balance and alignment

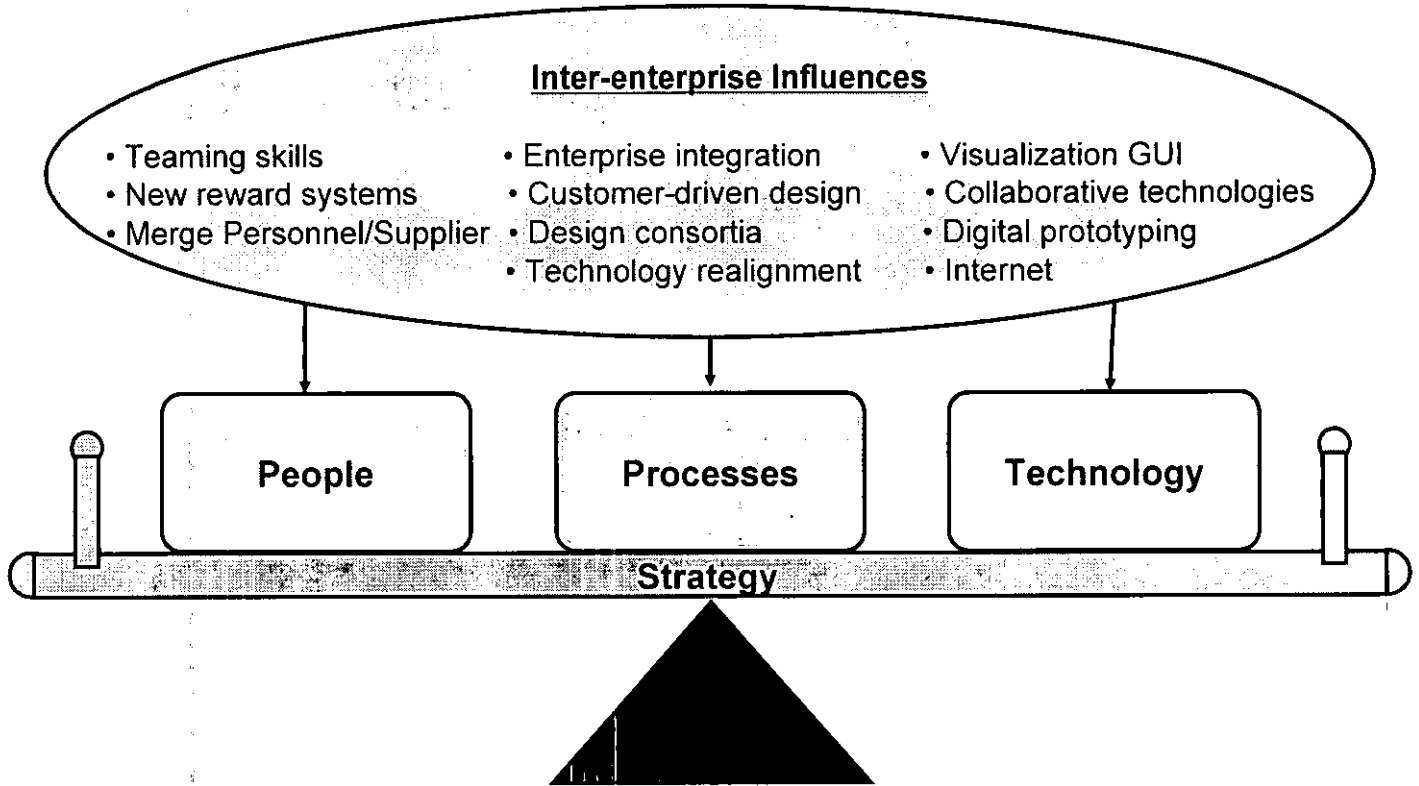

What is a Virtual Company?

- No Employees
- On Demand Access to World Class Resources & Personnel
- Heavy Emphasis on WWW and e-mail
- Few Brick & Mortar Offices
- Very Low Overhead
- Rapid Access & Decision Making for All Enterprise Elements
- Rapid Reconfiguration of Business Alignments & Partners
- Extensive Intellectual Property which is basis for internal investments



Bob Carman 4/6/05

Inside VC

Management

Mobile

Hotel

Home

Permanent Shareholders

Permanent Board of Directors

CEO

Board Chairman

Frequent N on M
Direct
Communication
To/From All Elements
(WWW, e-mail, phone)

Design Team

Software

Hardware

Fabrication Team

Program Manager

Partner 1

Partner 2

Partner 3

Laboratory

Integration Partner

Raw Materials



Small Core Support Team
Bob Carman 4/6/05

How Does Chorus Motors plc Work

- Weekly Formal Status Telecoms with Board of Directors (BoD), key Stockholders and Management involving key "Employees"
- Weekly Formal Telecoms for Program Status & Direction involving program team, suppliers, customers and executive management
- Regular Informal Telecoms for strategic decision making, discretionary investment and intellectual property decisions, problem resolutions (involving all contributing and participating parties and executive management)
- Continuous e-mail involvement of all relevant people associated with any issue
- <48 hour access to all elements of the business (Investors, BoD, Executives, Program Managers, Employees, Suppliers, and Customers whenever needed)
- Total Empowerment of Team Members within well defined boundaries which are flexible and evolving continuously through dialog
- Customers contributing to solutions as team mates



Bob Carman 4/6/05

Can a Virtual Company Deliver Hardware?

- Supply Chain embedded much as people (No difference between suppliers and “employees”)
- On-Demand Factory Resources
- On-Demand development “laboratory” resources in rented company facilities with minimal capital equipment
- Custom Tailored & Re-configurable Enterprise to meet Customer Needs
- Company Valued Added Continuously Changing and Optimized to activities at hand

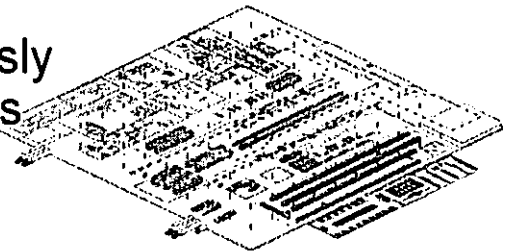
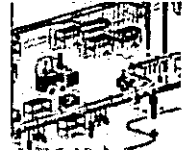

ABSOLUTELY!

Bob Carman 4/6/05

**Our Factory is Embedded
Suppliers & People**

Chorus Motors plc Results

- Program costs are 50-70% lower than traditional companies
- Program schedules are highly parallelized and 50-70% shorter than traditional companies
- Wasted resources due to untimely information eliminated
- Contract Draft Changes and Acceptance in <48 hours (involving 30-40 Chorus people at all levels)
- Total Management structure involves effectively two levels only
- Strategic plan is alive and evolving continuously on at least a weekly basis
- Intellectual Property Creation and Maintenance is a natural part of the work process
- Discretionary resources can be committed within a week to good ideas (birth to funding)
- Company Fund Raising is accomplished on a need basis (usually within one to two weeks)

ANALYSIS



CONCEPT



Bob Carman 4/6/05

Chorus Motors plc

Employees and Suppliers

- Employees (President to worker) are on-demand contracted labor
- Integrated part, sub-system and system suppliers are dealt with as on-demand partners
- Enterprise treats all people as "Family"
- Raw Material and Catalog Item Suppliers dealt with over the internet.

PROCESS

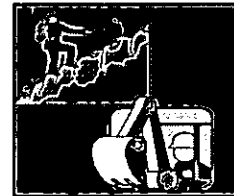

Bob Carman 4/6/05

Basis of Labor & Partner Agreements are Identical

- Facilities, Capital Equipment and other resources supplied as part of on-demand activity
 - Computers & ISPs
 - Cell Phones
 - Offices
 - Software Production Facilities
 - Machine Shops
 - Assembly Areas
 - Test Areas & Equipment
- Travel compensated after completion
- Specialized job performance enhancements pre-authorized and compensated after established

Bob Carman 4/6/05



Corporate Facilities

- Partners

- Production and Integration Facilities

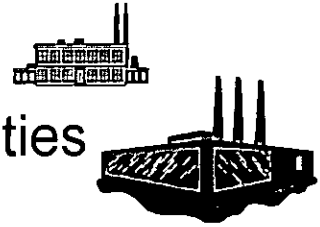

- Rented

- Laboratory Facilities

- Storage Facilities

- Owned

- Research Hardware and Test Equipment

- Versatile Power Generation Capabilities (Portable)

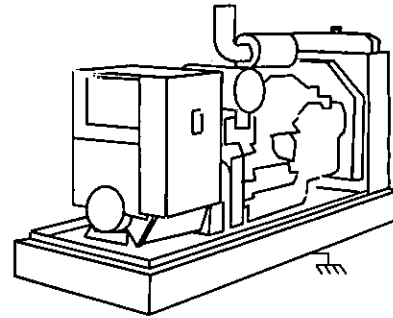
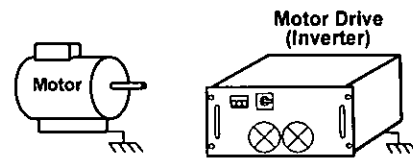

Diesel Generator



Bob Carman 4/6/05

Overhead Activities at Chorus Motors plc

- Common Pool Staff
 - On-Demand IT Resources
 - On-Demand Accounting/Payroll
 - On-Demand Patent Attorneys
 - On-Demand Legal Advisors
 - On-Demand Business Research
- Bookkeeping and Business Administration done at performance level by workers/program managers
- Sales performed by all personnel (Shareholders, BoD, Executives, Workers, Suppliers and Customers)



Bob Carman 4/6/05

Working Together

"Great discoveries and achievements invariably involve the cooperation of many minds."

Alexander Graham Bell



Virtual Companies have big advantages
in achieving the New Competitive Demands
& Global People/Resource Requirements

Bob Carman 4/6/05