

The background of the slide features a dark, high-contrast image of soldiers in a smoky or dusty environment. The soldiers are silhouetted against a lighter, hazy background, creating a sense of action and military readiness. The central figure is a soldier in the foreground, holding a rifle, with other soldiers visible behind them.

NEXT

DYNAMICS

NEXT GENERATION DEFENSE TECHNOLOGY

INVESTMENT OVERVIEW

February 2023

Safe Harbor Statement

This document contains statements related to our future business and financial performance and future events or developments involving Next Dynamics, Inc., that may constitute forward-looking statements. These statements may be identified by words such as “expect,” “look forward to,” “anticipate,” “intend,” “plan,” “believe,” “seek,” “estimate,” “will,” “project” or words of similar meaning.

We may also make forward-looking statements in other reports, presentations, materials delivered to shareholders and/or press releases. In addition, our representatives may from time to time make oral forward-looking statements. Such statements are based on the current expectations and certain assumptions of Next Dynamics, Inc.’s management, many of which are beyond Next Dynamics, Inc.’s control. These are subject to a number of risks, uncertainties and factors, including, but not limited to those described in disclosures, in particular in the “Risks” section in our Annual Report.

Should one or more of these risks or uncertainties materialize or should underlying expectations not occur or assumptions prove incorrect, actual results, performance or achievements of Next Dynamics, Inc. may (negatively or positively) vary materially from those described explicitly or implicitly in the relevant forward-looking statements. Next Dynamics, Inc., neither intends nor assumes any obligation to update or revise these forward-looking statements in light of developments which differ from those anticipated.

Executive Summary

Organization Overview

Ticker: OTC: NEXD

Industry: Defense

Shares Out: 23,147,500

Est Public Float: 134,222

Business Overview

- Next Dynamics Corp is a next-generation defense company with an innovative portfolio of ballistic technologies that will disrupt military and civilian firearms markets.
- NEXD has developed, and is near to market with, the Nemesis ASAP round, a revolutionary new projectile that has already proven superior to existing stagnant ammunition technology - and revitalizing the moribund military munitions space.

Highlights

Nemesis ASAP Validated & Proven

The Company is entering its third round of testing and validation with the Nemesis projectile, and, thus far, results have been nothing short of groundbreaking, exceeding expectations. The Company is engaged in ongoing testing of its ammunition of various calibers and plans to begin testing with a US DoD vendor in Q1/Q2 2023.

Initial Distribution & Licensing Opportunities

Next Dynamics has been aggressively pursued by major players in the defense space, introduced by members of the Board and Advisory Board, with potential licensing and distribution partners including major US defense contractors, foreign militaries, and international distributors as well as senior US military and DoD personnel.

Broad IP Portfolio of Defense Technology

NEXD holds patents from ballistic tech to military engineering upgrades. The Company's next near-to-market IP is the Star Chaser, an innovative A2G, G2A projectile for air defense and airborne assault. The full patent was completed in June. Other offerings planned near term include artillery modernizations and precision guided mortar munitions.

Key Target Markets

\$452B

Aggregate Global Defense Market

\$15.4B

Total Addressable Small Caliber Ammunition Market (2025 est)

\$18.5B

Global Military & Law Enforcement Ammunition

Next Dynamics is a technology development and licensing company focused on small + medium caliber ammunition.

Our team is comprised of some of the brightest minds in the field of small arms ammunitions, field armaments, weapons and global marketing strategy.

Led by our chief engineer, Antoni "Tony" Binek, a legendary figure in the defense engineering and ballistics space with over a half century of groundbreaking technical achievements, the development pipeline on the core Nemesis ASAP technology has been nearly seven years from conception to validation and represents the single greatest advancement in ballistic projectile technology in more than 60 years.

A Revolutionary New Ammunition Focused on Small & Medium Caliber

Our patented Advanced Small Arms Projectile (A.S.A.P.®) munitions cover the full spectrum of ground force applications across small and medium NATO calibers and weapons platforms.

Next Dynamic's ancillary product and technology offerings include:



Weapons (Barges, Drones, & Tactical Weapons)



Engineering (Customization / Retrofits / Upgrades)



Other Projects & Services (Munitions / Armaments)

Our defense technologies are patented, tested and proven.

Executive Team + Advisors



Andre Beauchesne

Chairman

An experienced entrepreneur and senior manager, Mr. Beauchesne has over 35 years of leadership experience. In addition to serving as head of Beauchesne Capital, he is Chairman of the cryptocurrency & fintech platform Alt5 Sigma, and is also Chairman of translation services player OXO Innovations.



Jacob Salk

President, CEO & Director

Mr. Salk is a seasoned financial executive, venture capitalist and investment banker with over \$11B in transactions over his career at Houlihan Lokey and other firms. A lifelong firearms aficionado, he is also a partner at M&A focused strategic advisory firm Zukin Partners. He is a founder, co-founder or advisor of several other enterprises.



Tony Binek

Principal Inventor
Chief Engineer & Director

Mr. Binek has over 50 years of experience in defense engineering, and holds numerous patents in innovative ballistics technologies. His accomplishments include developing the largest gun in the world for the USAF in 1970 and serving as Chief Engineer at the renowned HARP project in Barbados. Mr. Binek has been instrumental in the creation of the Company's technologies.



Jerome Cliché

Director & Senior Advisor

Jerome is a seasoned finance professional, skilled in investor relations, M&A, valuation, and financial communications. He is President of LMC Communications, Inc, an integrated marketing and investor relations company, and the co-founder of Renmark Financial Communications, where his clients included NYSE, Nasdaq, and TSE listed companies.



Sam Mouallem

Director

Mr. Mouallem is an engineer with 30 years experience in defense supply chain integration and procurement. He is Co-Founder & President of Simex Defense, Inc., the leading supplier of military and defense products to the Canadian military, with more than 1,500 contracts per annum with Canadian Department of National Defence.

Our executive team has a combined 200+ years of experience in engineering, ballistics, defense technology, finance & global marketing strategy & our Advisory Board has over 60 combined years of military service.

Executive Team + Advisors (Cont.)



**Philippe
Vintila**

VP, Business
Development

A professional engineer by trade, Mr. Vintila helms the Company's strategic relationships, which will become increasingly important as the ASAP technology is licensed to manufacturers and distributors. He also serves as the Company's Canadian Controlled Goods official. Prior to joining Next Dynamics, Mr. Vintila worked for one of Canada's largest construction / engineering companies where he coordinated infrastructure projects, including a CAD\$7B light rail installation in the Greater Montreal region.



**Adm. Greg
Slavonic**

Military Advisory
Board Chair

Admiral Slavonic has spent nearly 40 years in leadership positions in public, political, and military affairs, with wartime naval service including the Vietnam, Gulf War, and Iraq War conflicts. Most recently he served as acting Undersecretary of the Navy, and Assistant Secretary of the Navy. Admiral Slavonic brings a wealth of military and political connections and insights, having served as Chief of Staff for Sen. James Lankford (R-OK), and as President of Flagbridge Strategic Communications.



**Lindsay
Kough**

Military Advisor

Commander Kough served more than twenty years as a US Navy SEAL and naval officer, and has an extensive background as a start-up CEO and senior banking/ financial services executive, most recently as CEO of a government contractor. He also served as Chief of Staff to the Undersecretary of the Navy, where he helped oversee a budget of \$211 billion and 900,000 personnel. Commander Kough brings integral relationships within the special forces community and a wealth of experience in monetizing government contracts.



**Bill
Coultrup**

Military Advisor

Col (ret) Bill Coultrup served 30 years in the US Army, with 24 years in multiple Special Operations units, commanding troops in various continents and combat zones. Most recently, Bill served as US SOCOM Legislative Affairs Director interacting with Congress on all matters pertaining to SOCOM. After the military, he worked in the Aerospace & Defense field continuing to support US and Allied forces in critical overseas missions. Bill currently serves as president of Republic Mission Systems, where he consults heavily with the Department of Defense.

Investment Highlights



NEXD has created, tested and proven the ASAP Nemesis round, a revolutionary projectile that will fundamentally transform a stagnant military ammunition space.



Next Dynamics has built an innovative portfolio of defense technology that will address substantial and underserved military requirements in an evolving and increasingly hostile global environment.

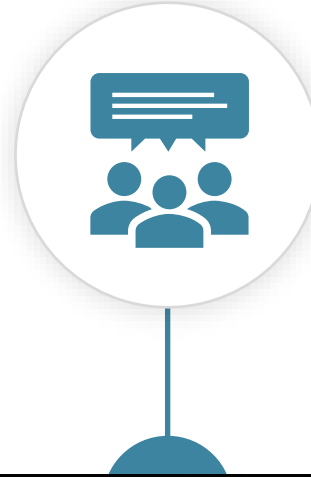



NEXD has initiated promising licensing and sales efforts for its Nemesis ASAP round, with substantial interest from major defense contractors, foreign militaries, potential foreign licensing partners, and US military personnel.



Ukraine tailwinds are driving a renewed defense industry investment cycle, with a focus upon many of the heretofore overlooked military technologies where NEXD specializes, notably artillery and ballistics.

Growth Catalysts

 Near term distribution / licensing wins expected for the Nemesis ASAP in FY 2023

 Broad product offering of close to market defense technologies

 World class research team with extensive industry acumen & proven record of success

 Additional suite of innovative products beginning with the Star Chaser round in Q1 '23

 BoD and Military Advisory Board offer best-in-breed market access to US / NATO militaries



Proven + Disruptive Ballistics

Once the bullet exits the barrel, captured gas is released, thereby reducing base drag.



BARNES
150gr VOR-TX



BARNES
150gr VOR-TX



BARNES
150gr VOR-TX



Extended Maximum
Effective Range



Reduced Drag &
Extreme Precision



Increased Terminal
Velocity & Lethality



Outstanding Armor
Penetration Capabilities



Improved Gyroscopic
Stability & Ballistics



NEMESIS 150gr
GEN1 - NO Booster



NEMESIS 150gr
GEN1 - WITH Booster

Projectiles
recovered in sand @
100 meters (328ft)
**NEMESIS with Booster
destroyed the target**

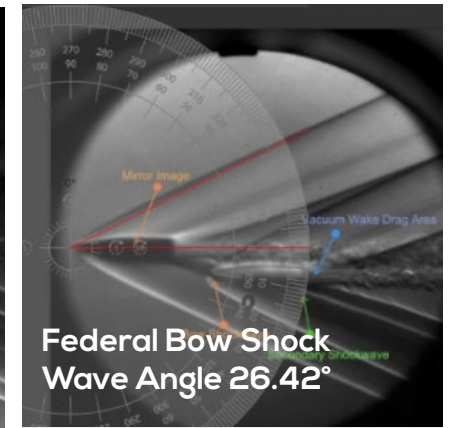
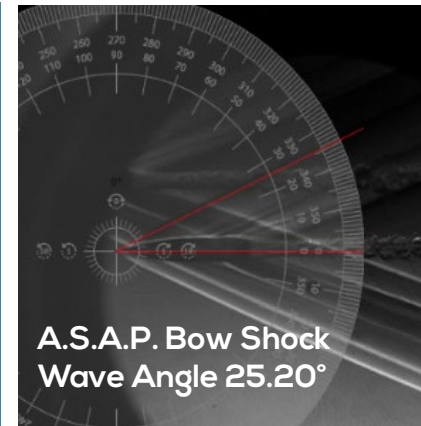

Existing Projectile Technology Is Outdated and Archaic.

01 A Complacent & Stagnant Industry

There have been few real advancements in projectile technology over the last 60 years.

02 Velocity Not a Focus

Most advancements focus on load size, tracers and new calibers.

03 Unharnessed Energy

Roughly 70% of gun gas generated at propellant ignition is wasted with typical projectiles.

04 Low-Impact Innovation at Competitive Price Point

Novel cartridge materials may offer lower weight or reduced heat transfer, but don't provide tangible ballistics improvement. The ASAP round provides superior performance at an appropriate price point.

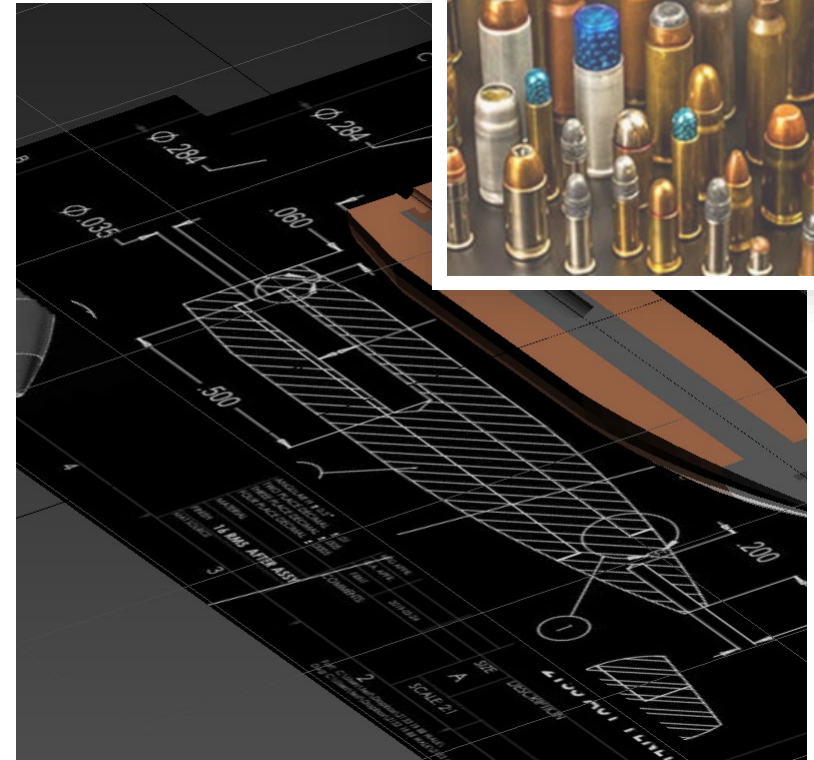

Groundbreaking Projectile Design

Our A.S.A.P.® projectiles exploit gun gas generated at combustion of gun powder in the barrel by storing it inside the projectile.

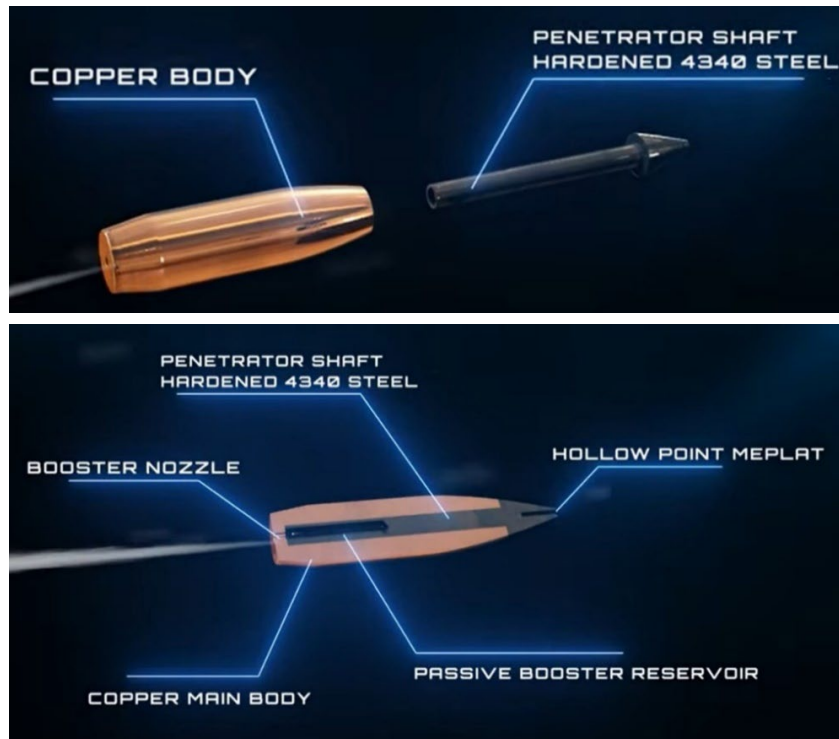

Our patented designs result in significantly increased velocity, range and lethality.

Groundbreaking Projectile Design (Cont.)

Managing the flow of gas inside the bullet requires chambers and orifices of various geometries.

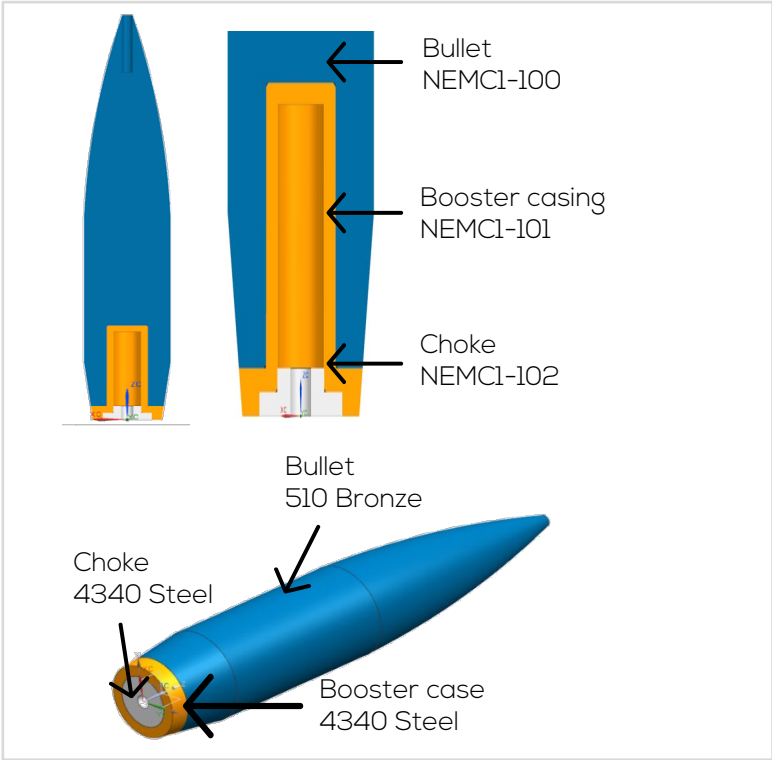
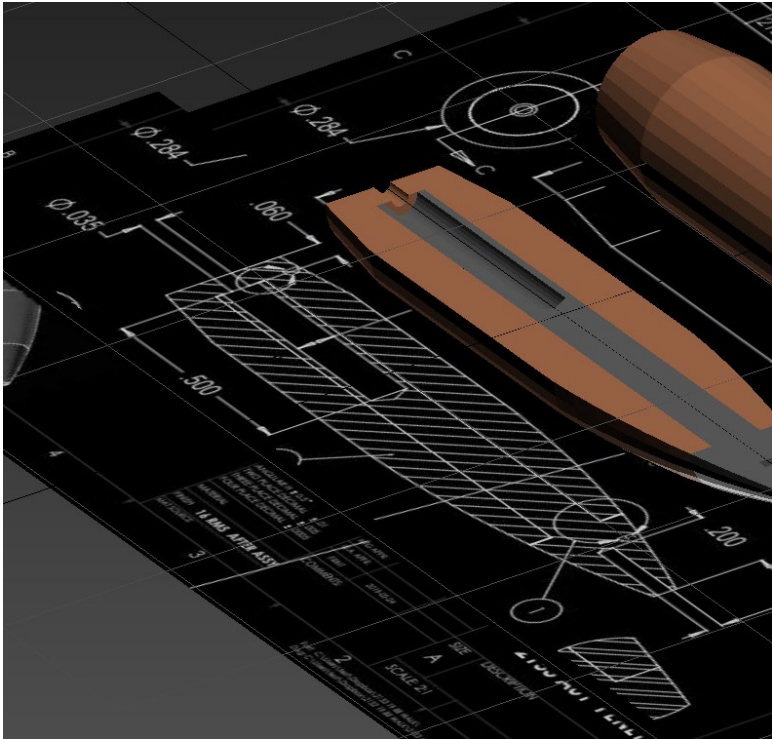

The entire projectile assembly is locked together by the "G" forces of acceleration in flight.

Outstanding Test Results

Our Nemesis A.S.A.P.® projectiles achieve superior ballistics results versus traditional munitions.

7.62 Round	Velocity (f/s)					
	Muzzle	100 yds	200 yds	300 yds	400 yds	500 yds
Fiocchi 150 Gr. FMJBT	2,890	2,658	2,439	2,229	2,030	1,842
Hornady Custom - 150Gr. SST	2,820	2,601	2,392	2,192	2,003	1,823
Federal American Eagle 150 Gr. FMJBT	2,820	2,597	2,385	2,183	1,990	1,808
Federal (Lake City) - 149 Gr. FMJ XM80CS	2,790	2,591	2,401	2,219	2,045	1,878
PMC 147 Gr. FMJBT	2,780	2,575	2,380	2,194	2,018	1,851
Winchester White Box 147 Gr. FMJ Q3130	2,750	2,534	2,329	2,132	1,946	1,770
Remington UMC 150 Gr. FMJ	2,820	2,533	2,263	2,009	1,774	-
Federal Power Shok - 150 Gr. JSP	2,820	2,532	2,261	2,007	1,771	1,557
Winchester Super-X 150 Gr. PP	2,820	2,513	2,227	1,960	1,713	1,492
Hornady Critical Defense - 155 Gr. FTX	2,785	2,499	2,231	1,980	-	-
COMPETITORS AVERAGE (fps)	2,810	2,563	2,331	2,111	1,921	1,753
Average Change in Velocity - Muzzle to Noted Distance (fps)		(246)	(479)	(699)	(888)	(1,056)

NEMESIS 7.62 TESTING DATA - STERLING CROSS & BORNEA DYNAMICS			
Nemesis Test Load	Average Velocity (fps)		
	Muzzle	100 Yds	300 Yds
145 gr 7.62 Projectile w/ 42.3gr 4895 Propellant (Sterling Cross)	2,792	2,611	N/A
145gr 7.62 Projectile w/ 42.1gr 4350 Propellant (Bornea Dynamics)	2,795	N/A	2,389
150gr Winchester Super-X 7.62 Projectile (Bornea Dynamics)	2,815	N/A	1,971
Average Change in Velocity - Nemesis (fps)		(181)	(406)
Average Change in Velocity - Competitors (fps)		(246)	(699)
Improvement in Change in Velocity - Nemesis vs. Comps Average		26.5%	41.9%
Change in Velocity - Winchester Super-X 150gr (fps)		N/A	845
Improvement in Change in Velocity - Nemesis vs. Winchester Super-X		N/A	51.9%
Absolute Improvement in Velocity - Nemesis vs. Winchester Super-X			21.2%



The top 10 competitors have a 246 fps average reduction in velocity from muzzle to 100 yds down range, and a 699 fps average velocity reduction at 300 yards. Next Dynamics' Nemesis 7.62 projectile has achieved an average reduction in velocity of 181 fps from muzzle to 100 yards down range, representing a **26.5% improvement over the average of the competitors' rounds**. At 300 yards, the most common battlefield range, the Nemesis projectile had a **41.9% improvement over competitors' average performance**. In testing completed by Bornea Dynamics, Nemesis achieved nearly 52% improvement in reduction in velocity between muzzle and 300 yards versus the Winchester Super-X round.

Note: Sterling Cross in-field (non-laboratory) testing completed June 2022.

Outstanding Test Results (Cont.)

Nemesis 7mm Remington Test Results

Banco Nazionale di Prova, Italy – February 2020

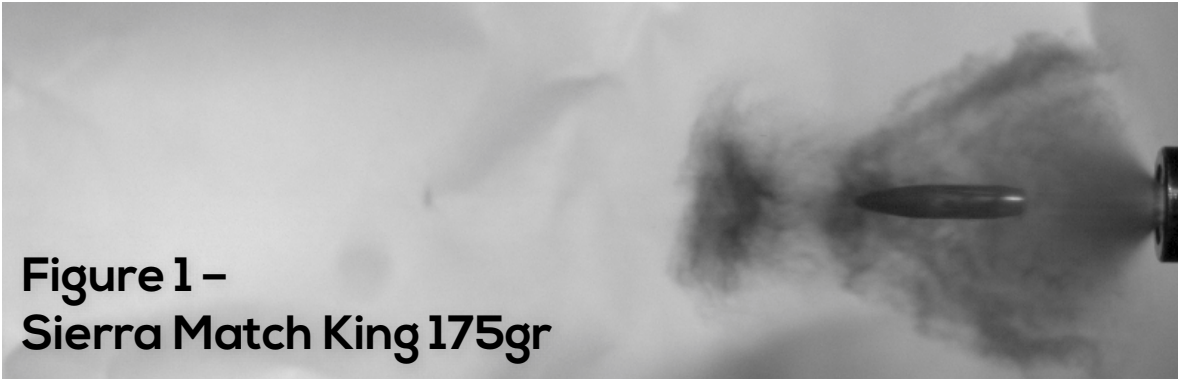

➤ Figure 1 shows a Sierra Match King (175gr) projectile in 7mm Remington at muzzle. The measured retardation of this projectile was 1.153m/sec/m.

➤ Figure 2 shows a Next Nemesis A.S.A.P. (155gr) projectile in 7mm Remington at muzzle. The measured retardation of this projectile was 0.564m/sec/m. **Note the unique plume effect created by the booster.**

➤ Drag reduction of A.S.A.P. vs. the Sierra projectile was anticipated to be ~30%.

The test provided for an astounding 51% improvement in drag reduction (peak measurement) relative to the Sierra 7mm reference projectile.

Note: The images above are stills from video captured during testing of Next A.S.A.P. projectiles against Sierra brand reference projectiles. Testing completed February 2020.

Intellectual Property

Next Dynamics holds numerous global patents (continuation patents pending) on its projectile technology, with a priority date of March 2017.



Next Dynamics recently completed the full patent application filing for its Star Chaser projectile technology (ref 020091-0014) on June 29, 2022.

Internal Reference Number	Country / Territory	Assigned Serial Number	Documentation Received
018250-0006	Canada	3,057,865	Notice of National Entry
018250-0007	United States	16/497,861	Certificate Received
018250-0008	Israel	Not Yet Received	Not Yet Received
018250-0009	South Africa	2019 / 06592	Filing Particulars
018250-0010	Europe	18,777,452	Acknowledgement of Receipt
018250-0011	South Korea	10-2019-7031773	Filing Certificate
020091-0014	International	Not Yet Received	Application Filed

Product Roadmap

A-1 7mm Remington – reduction of base drag & improved penetration
(Production Completed)

A-X 5.56mm – reduction of base drag, improved penetration
A-P 5.56mm – standard bullet, high penetration power
(Production Completed; Testing in Progress)

12.7mm Star Chaser – frontal/skin drag reduction
7.62mm Star Chaser – frontal/skin drag reduction
(Full Patent Filed; Dev comp Nov; Prod starting Dec/Jan)

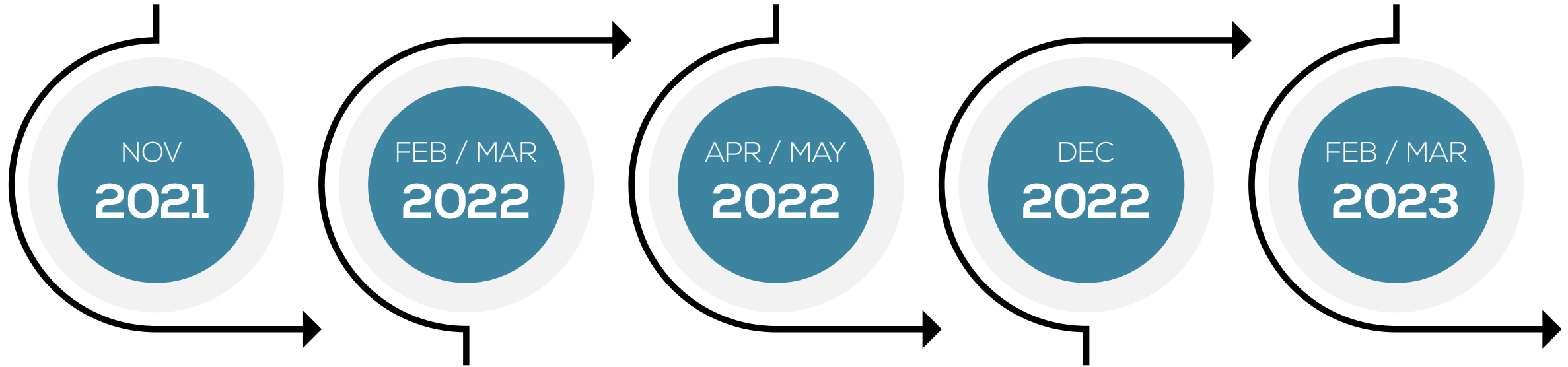

A-X 140gr 7.62mm – standard weight, improved penetration
A-P 140gr 7.62mm – standard weight, high penetration
A-X 170gr 7.62mm – heavy weight, improved penetration
A-P 170gr 7.62mm – heavy weight, high penetration
(Production & Testing Nearing Completion)

A-X 12.7mm (.50 cal) – reduction of base drag, improved penetration
(Production Started November)

Other Engineering Services + Projects

Next Dynamics is developing incremental ammunitions technology, and also offers modernization + customization for existing artillery weapons of various classes which improve performance and longevity, at significantly reduced cost versus replacement.



Star Chaser Ammunition

- Star Chaser projectiles developed with additive digital manufacturing (gas flow inside bullet) or standard machining
- Offered in 7.62mm + 12.7mm (.50 cal)
- Designed for very short flight time, suitable to be launched from and attack airborne targets



M101-R2/C3 Howitzer Modernization

Next Dynamics' Howitzer Upgrades Include:

- Address catastrophic structural failure
- Enhanced range (11.0-18.5 km, same as M119)
- Increased ammunition choices
- Cost reduction of 25%-50% vs. unit replacement



Other Projects

Apache Hybrid Power Drone

- Armed With 19.5mm Recoil-less Rifle

Precision Guided Mortar Munition

- Retrofit For 120mm + 105/155mm Mortar

B5 Barge W/ .45 Mark45 Naval Gun

- Total suppression of air, water, or land targets

Manufacturing, Testing, Licensing & Distribution

Next Dynamics has partnered with best-in-class defense companies for the manufacturing, testing, licensing & distribution of our products.

Projectile Manufacturing



Cartridge Loading & Testing

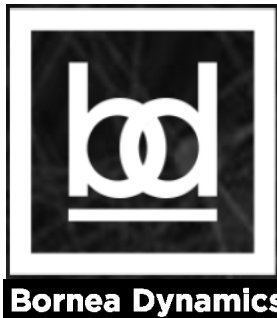

Licensing & Distribution*



We seek to leverage our intellectual property, manufacturing relationships & distribution network to deliver trail-blazing technology to major target global defense groups.

From a technology development standpoint, we have accomplished the heavy lifting, and we look forward to custom-tailoring our technology to any client's desired specifications.

*As of November 1, 2021, Next Dynamics and Simex Defence have formed a non-exclusive joint venture, Next Dynamics Simex Consortium ("NDS"), for the purpose of achieving licensing and distribution of Next Dynamics' products.

Large & Growing Defense Market

Global Ammunition Market

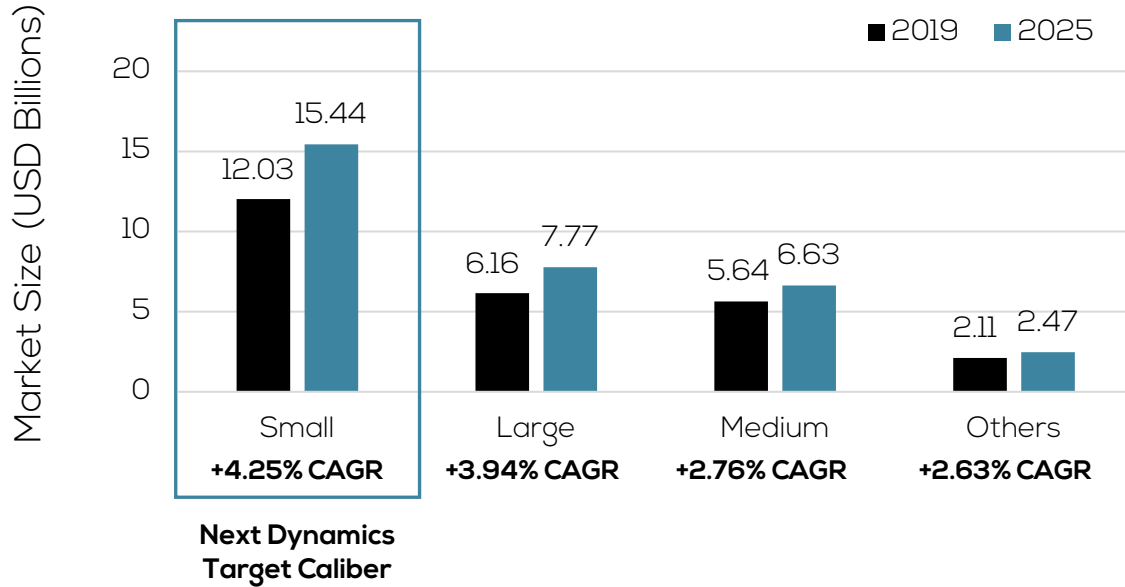

SMALL ARMS MARKET

Type	2017	2018	2019	2025	CAGR (2019-2025)
5.56mm	5.43	5.69	5.96	7.83	4.66%
7.62mm	3.09	3.21	3.34	4.19	3.87%
12.7mm	1.75	1.82	1.89	2.38	3.91%
14.5mm	0.79	0.81	0.84	1.04	3.52%
Total	11.05	11.54	12.03	15.44	4.24%

Target market; in billions \$ USD

Military & Law Enforcement Market

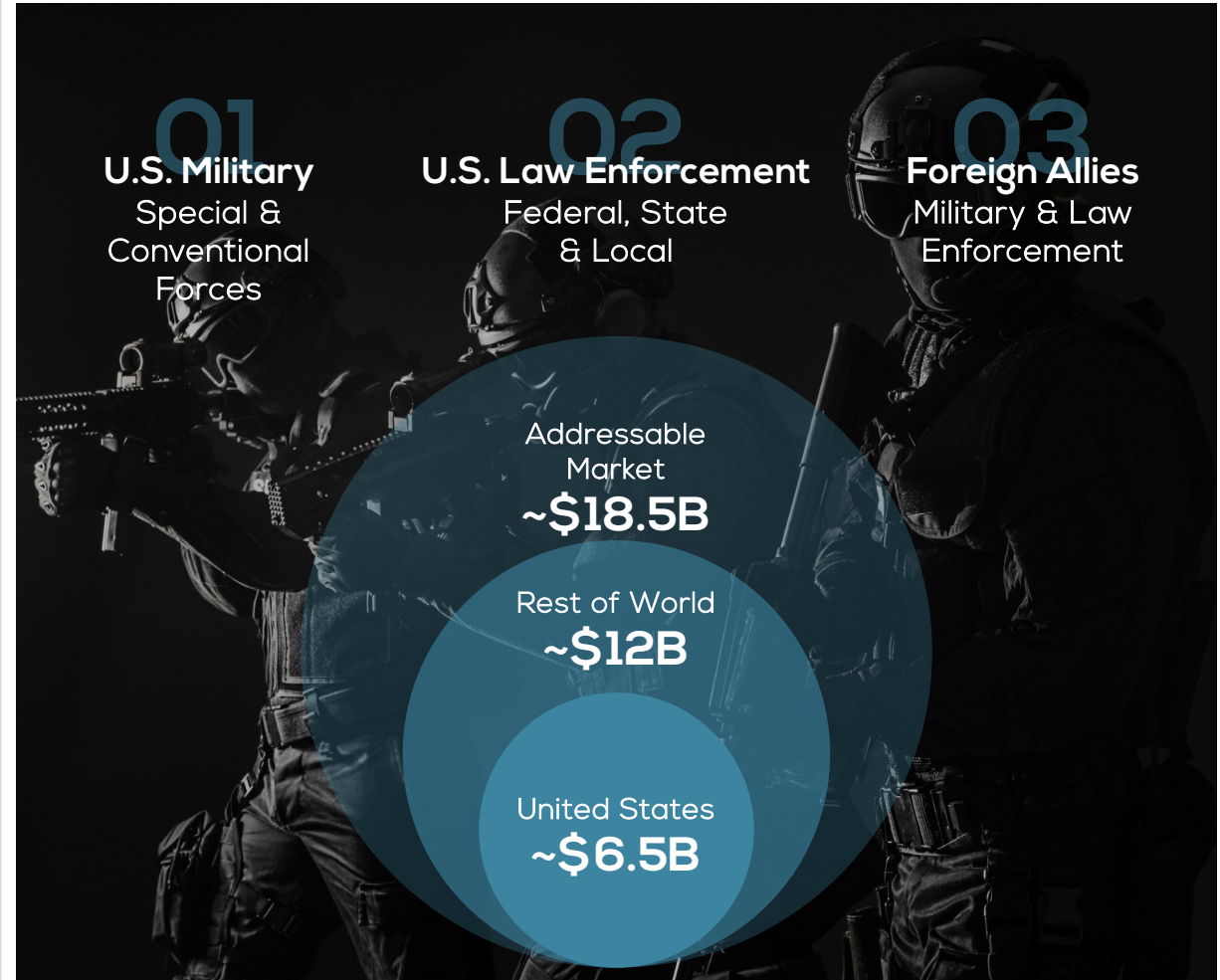

Source: Secondary Research, Expert Interviews, Markets & Markets Analysis

Global Defense Market Analysis

Market Drivers

- Strategic challenges posed by rising competitors to US/NATO unipolarity, notably Chinese military expansion and Russian adventurism in Ukraine and the Caucasus, has spurred a new Cold War that is expected to drive a wave of post GWOT military budgets and technology
- Notable lessons of the Ukraine conflict have been the importance of previously overlooked technology and tactical products; the renewed importance of artillery support, the pivotal role of UAV's in spotting and identification, and the superior ballistic weapons and optics technology of Western forces, some of which are particularly relevant for NEXD.
- Investment in the ammo space has been primarily focused on ancillary developments, such as authorized biometric/ RFID sensors, smart locking, new polymer manufactures, and 3D printing, while the core tech, which the Nemesis ASAP has targeted, is still untapped.
- Attractive M&A environment with highly fragmented industry - from both sell and buy side

Highlights

- The US and global defense industries are in the midst of a generational change, the most notable period since the fall of the Berlin Wall. The defense industry is realigning itself and changing the focus of their technology investments in the wake of new geopolitical dynamics, and anticipated reinvestment in military capabilities – while the pre-Ukraine trend was towards increasing consolidation of defense industry players with commercial technology interests (notably the Raytheon-United Technologies merger), but major defense contractors such as Boeing, General Dynamics, Airbus, and Thales provide further examples.
- Post-Ukraine, however, we foresee a far more diverse and responsive market with a plethora of M&A opportunities for smaller and more nimble players, especially those that are more attuned to military technology improvements with more tangible implementation cycles.

Global Defense Market
US\$513.6 billion (2022)
Predicted to Reach
\$604 B by 2026

Global Defense Market Size 2022 -2026

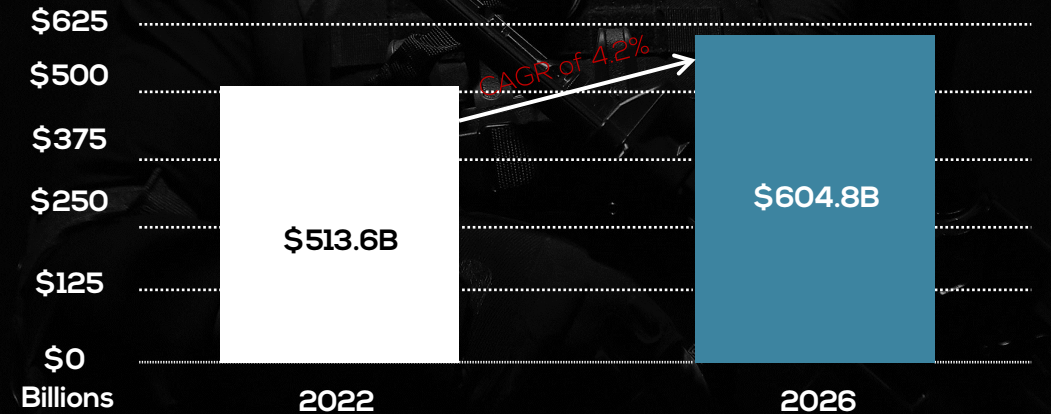

Competitive Landscape

Premium Products



OEM / Manufacturing

Technology Licensing

Company History + Roadmap

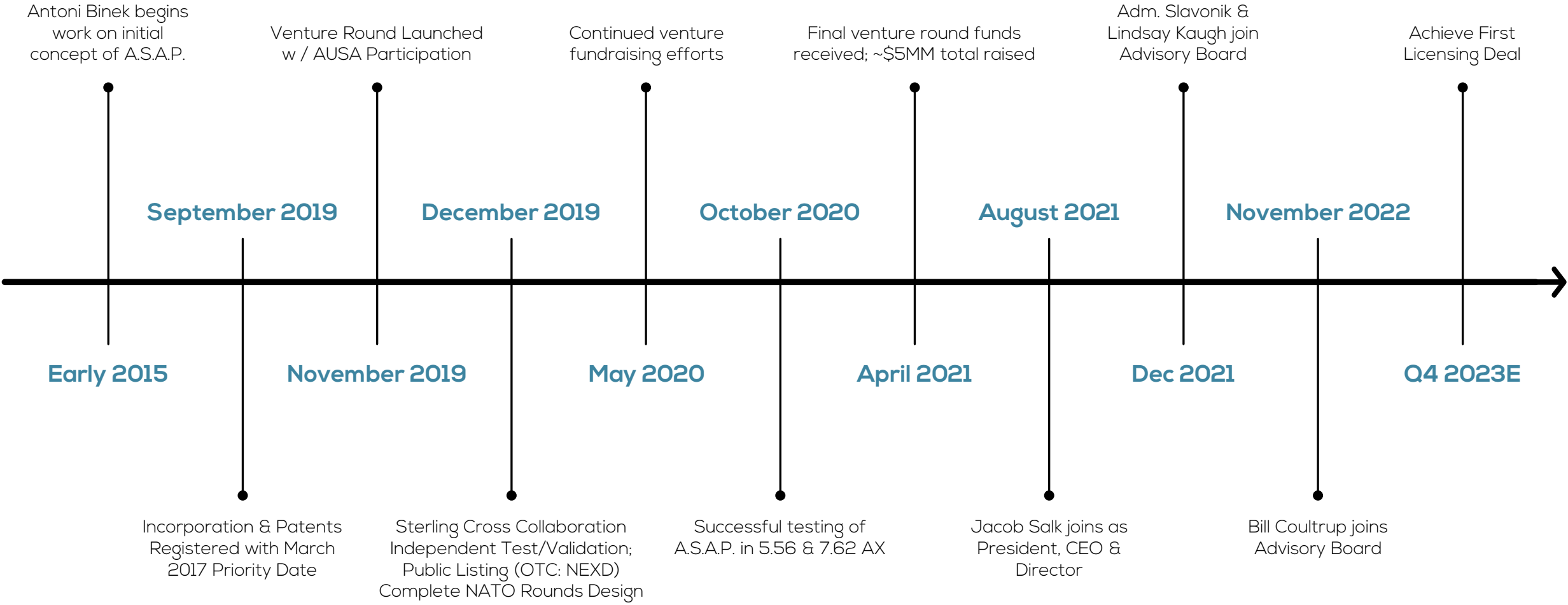

Capitalization & Use Of Proceeds

Shareholder	Shares Held	% Fully Diluted
Officers & Directors	9,690,074	41.9%
All Others	13,457,161	58.1%
Total Shares	23,147,535	100.0%

Use of Proceeds Analysis

Sources of Cash	Amount	Uses of Cash	Amount
New Financing	\$1,500,000	General & Administrative	\$665,662
		Manufacturing & Testing	532,529
		Sales & Marketing	133,132
		Loan Repayment	56,177
		Illustrative Transaction Fee	112,500
Total Cash Sources	\$1,500,000	Total Cash Uses	\$1,500,000

Outlook

Near Term Operations

- Next Dynamics Corp is currently finalizing testing and validation of the Nemesis ASAP projectile, with testing being conducted at Bornea Dynamics; following which it will undertake testing with a US DoD contractor in North Carolina, a process that is expected to commence early Q2 2023. All testing thus far has exceeded expectations. This will serve to validate the ASAP with exposure to early adoption markets in the US DoD / military and other NATO forces.
- The Company's Board of Directors and Military Advisory Board have been instrumental in developing and exploring these potential relationships. In addition to interest from one of the USA's largest primary defense industry contractors, the Company has been in active discussions with US military officials, as well as foreign militaries. The Company is working diligently toward closing its first license / distribution arrangement by the end of 2023.

Financing Efforts

- \$1.5 million Regulation CF offering is now underway, with intent of providing financing to fully complete testing and validation of the Nemesis ASAP projectile concurrent with licensing / distribution efforts.
- The Company intends to follow the Reg CF with a \$5+ million Regulation A round later in the year, which will focus on post-market engineering and development of the Company's Star Chaser round, other engineering projects and facilitate additional IP and administrative efforts in order to bring the Company into reporting compliance for up-listing.
- Focus on the fully-reporting public vehicle up-listing to a senior US market by year end 2023, where the intrinsic value of the Company's defense technology suite will receive more concerted investor attention, with commensurately higher and more appropriate valuation levels, for acquisitions or additional development projects.



THANK YOU



JACOB SALK

President & CEO

jacob@nextdynamicscorp.com



(510) 520-6063